

Каталог

По вопросам продаж и поддержки обращайтесь:

Алматы (727)345-47-04
Ангарск (3955)60-70-56
Архангельск (8182)63-90-72
Астрахань (8512)99-46-04
Барнаул (3852)73-04-60
Белгород (4722)40-23-64
Благовещенск (4162)22-76-07
Брянск (4832)59-03-52
Владивосток (423)249-28-31
Владикавказ (8672)28-90-48
Владимир (4922)49-43-18
Волгоград (844)278-03-48
Вологда (8172)26-41-59
Воронеж (473)204-51-73
Екатеринбург (343)384-55-89

Иваново (4932)77-34-06
Ижевск (3412)26-03-58
Иркутск (395)279-98-46
Казань (843)206-01-48
Калининград (4012)72-03-81
Калуга (4842)92-23-67
Кемерово (3842)65-04-62
Киров (8332)68-02-04
Коломна (4966)23-41-49
Кострома (4942)77-07-48
Краснодар (861)203-40-90
Красноярск (391)204-63-61
Курск (4712)77-13-04
Курган (3522)50-90-47
Липецк (4742)52-20-81

Магнитогорск (3519)55-03-13
Москва (495)268-04-70
Мурманск (8152)59-64-93
Набережные Челны (8552)20-53-41
Нижний Новгород (831)429-08-12
Новокузнецк (3843)20-46-81
Ноябрьск (3496)41-32-12
Новосибирск (383)227-86-73
Омск (3812)21-46-40
Орел (4862)44-53-42
Оренбург (3532)37-68-04
Пенза (8412)22-31-16
Петрозаводск (8142)55-98-37
Псков (8112)59-10-37
Пермь (342)205-81-47

Ростов-на-Дону (863)308-18-15
Рязань (4912)46-61-64
Самара (846)206-03-16
Санкт-Петербург (812)309-46-40
Саратов (845)249-38-78
Севастополь (8692)22-31-93
Саранск (8342)22-96-24
Симферополь (3652)67-13-56
Смоленск (4812)29-41-54
Сочи (862)225-72-31
Ставрополь (8652)20-65-13
Сургут (3462)77-98-35
Сыктывкар (8212)25-95-17
Тамбов (4752)50-40-97
Тверь (4822)63-31-35

Тольятти (8482)63-91-07
Томск (3822)98-41-53
Тула (4872)33-79-87
Тюмень (3452)66-21-18
Ульяновск (8422)24-23-59
Улан-Удэ (3012)59-97-51
Уфа (347)229-48-12
Хабаровск (4212)92-98-04
Чебоксары (8352)28-53-07
Челябинск (351)202-03-61
Череповец (8202)49-02-64
Чита (3022)38-34-83
Якутск (4112)23-90-97
Ярославль (4852)69-52-93

Россия +7(495)268-04-70

Казахстан +(727)345-47-04

Беларусь +(375)257-127-884

Узбекистан +998(71)205-18-59

Киргизия +996(312)96-26-47

эл.почта: kun@nt-rt.ru || сайт: <http://konuscopes.nt-rt.ru/>



RIFLESCOPES

Having been a true leader of the optical industry for 46 years and counting, Konus is now releasing some of its most unique and most exciting riflescopes ever. For example the # 7177 Invincible, a 5-50x60 model with 34mm tube that takes full advantage of the incomparable clarity and brightness of the finest ED glass. Or the # 7193 Sultan, a supremely versatile 1-10x24 model with unique reticle and zero-stop turrets. Or the incredibly affordable Wild series (with 30mm tube) and Fighter series (with 1" tube) that are an ideal solution for sportsmen on a tight budget.

"This scope has one of the clearest glass I've ever looked through. Konus has always been able to pull off some sort of voodoo whereby it brings a remarkable product to the table without a heavy price point."

Frank Melloni, Gun Digest magazine



SECOND FOCAL PLANE



IDEAL FOR LONG DISTANCE SHOOTING



34MM TUBE DIAMETER

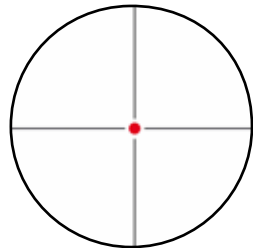

#7177 5x-50x60 ZOOM
FINE CROSSHAIR WITH ILLUMINATED DOT

FEATURES

- › ED GLASS
- › 34MM TUBE
- › ENGRAVED RETICLE WITH ILLUMINATION
- › HYDROPHOBIC LENS COATING SUITABLE FOR RAINY DAYS
- › HIGH PRECISION TACTICAL TURRETS WITH ZERO-STOP FUNCTION
- › AUTO SHUT-OFF WITH SHAKE-AWAKE FUNCTION
- › 1/8 M.O.A. ADJUSTMENTS
- › WATERPROOF, FOGPROOF, SHOCKPROOF
- › FULLY MULTI COATED OPTICS
- › SUNSHADE INCLUDED
- › EXCEPTIONAL OPTIC PERFORMANCE WITH DISTORTION-FREE RESOLUTION
- › REMOVABLE ZOOM LEVER

CODE	7177
MAGNIFICATION X OBJECTIVE DIAMETER	5-50X60 ZOOM
RETICLE	FINE CROSSHAIR WITH ILLUMINATED DOT
FIELD OF VIEW (AT 100M/YDS)	7.5M - 24.6 FT AT 5X 0,75M - 2.46 FT AT 50X
WEIGHT (GR/OZ)	950GR - 33.51 OZ
LENGTH (MM/INCHES)	408MM - 16.04"
EYE RELIEF (MM/INCHES)	110MM -4.33" AT 5X 92MM - 3.62" AT 50X
EXIT PUPIL (MM)	8 AT 5X - 1.2 AT 50X
CLICK VALUE (AT 100M/YDS)	1/8 M.O.A.
ADJUSTING RANGE (AT 100M/YDS)	> 65 M.O.A.
MOUNTING LENGTH (MM/INCHES)	185MM - 7.28"

THE ULTIMATE RIFLESCOPE FOR LONG DISTANCE SHOOTING

To go along with an outstanding 5x-50x zoom power and a generous 60mm objective diameter, this model has been engineered with every conceivable feature that can improve your accuracy while you are taking the most prohibitive shot. True ED glass for flawless optical brilliance. 34mm tube for enhanced light-gathering capability. Zero-stop turrets with professional grade reliability. Engraved and especially thin reticle of the Fine Crosshair type with illumination. Auto shut-off with shake-awake technology. Fully multi-coated optics with distortion-free resolution and hydrophobic treatment. This is therefore the absolute top of the line among Konus riflescopes.



SECOND FOCAL PLANE



IDEAL FOR HUNTING



30MM TUBE DIAMETER



SULTAN



#7193 1x-10x24 ZOOM
ENGRAVED ILLUMINATED
BALLISTIC-CIRCLE RETICLE

FEATURES

- › 30MM TUBE
- › ENGRAVED AND ILLUMINATED BALLISTIC-CIRCLE RETICLE
- › TACTICAL TURRETS WITH ZERO-STOP FUNCTION
- › WATERPROOF, SHOCKPROOF, FOGPROOF
- › FULLY MULTI-COATED OPTICS
- › PRECISION 1/4 M.O.A. ADJUSTMENTS
- › REMOVABLE ZOOM LEVER
- › FLIP-UP COVERS INCLUDED

CODE	7193
MAGNIFICATION X OBJECTIVE DIAMETER	1-10X24 ZOOM
RETICLE	ILLUMINATED BALLISTIC CIRCLE
FIELD OF VIEW (AT 100M/YDS)	36.3M - 119.2 FT AT 1X 3.67M - 12.05 FT AT 10X
WEIGHT (GR/OZ)	600 GR - 19.75 OZ
LENGTH (MM/INCHES)	273 MM - 10.74"
EYE RELIEF (MM/INCHES)	89.9MM - 3.54" AT 1X 86.8MM - 3.42" AT 10X
EXIT PUPIL (MM)	10 AT 1X - 3 AT 10X
CLICK VALUE (AT 100M/YDS)	1/4 M.O.A.
ADJUSTING RANGE (AT 100M/YDS)	120 M.O.A.
MOUNTING LENGTH (MM/INCHES)	186MM - 7.32"

THE ULTIMATE RIFLESCOPE FOR HUNTING

A truly revolutionary model with an incomparably versatile 10x zoom system that will assist you while shooting at literally any given distance. Combining an exclusive reticle design with highly professional zero-stop turrets, this riflescope is guaranteed to maximize your ballistic performance in the field and is also being offered at a price that is unheard of.

ETERNITY



FIRST FOCAL PLANE



IDEAL FOR LONG DISTANCE SHOOTING



30MM TUBE DIAMETER

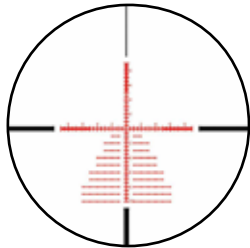

#7295 6x-24x50 ZOOM
PRS BALLISTIC RETICLE WITH RED ILLUMINATION



REMOVABLE TURRET CAP WITH ZERO-STOP FUNCTION

FEATURES

- › FIRST FOCAL PLANE
- › HIGH PRECISION LOCKING TACTICAL TURRETS WITH ZERO-STOP FUNCTION
- › CONSTANT LONG EYE RELIEF AT ALL MAGNIFICATION
- › COMPACT DESIGN WITH WIDE FIELD OF VIEW
- › SIDE PARALLAX WHEEL
- › EXCEPTIONAL OPTICAL PERFORMANCE WITH DISTORTION-FREE RESOLUTION
- › ULTRA WIDE BAND FULLY MULTI-COATING FOR HIGH TRANSMISSION AND INCREDIBLE CLARITY
- › HYDROPHOBIC LENS COATING SUITABLE FOR RAINY DAYS
- › REMOVABLE ZOOM LEVER AND SUNSHADE
- › ENGRAVED RETICLE ILLUM. IN RED WITH 11 INTENSITIES

CODE	7295
MAGNIFICATION X OBJECTIVE DIAMETER	6-24X50 ZOOM
RETICLE	ENGRAVED ILLUMINATED PRS BALLISTIC RETICLE
FIELD OF VIEW (AT 100M/YDS)	6.4M - 20.9FT AT 6X 1.6M - 5.2 FT AT 24X
WEIGHT (GR/OZ)	845GR - 28.8OZ
LENGTH (MM/INCHES)	390MM - 15.3"
EYE RELIEF (MM/INCHES)	86MM - 3.3" AT 6X 81MM - 3.1" AT 24X
EXIT PUPIL (MM)	5 AT 3X - 2.6 AT 12X
CLICK VALUE (AT 100M/YDS)	1/10 MIL
ADJUSTING RANGE (AT 100M/YDS)	45 MOA
MOUNTING LENGTH (MM/INCHES)	173MM - 6.8"

EASY TO OPERATE ZERO-STOP TECHNOLOGY

Developed with the superb precision of a First Focal Plane system and equipped with a supremely accurate and versatile reticle of the PRS ballistic type, this 6-24x50 riflescope is especially notable for its extremely accessible zero-stop technology. This model comes with two interchangeable caps for the elevation turret: a regular cap for zeroing the riflescope in the fastest and easiest way and another special cap for enabling the zero-stop function whenever you want it. Just like that: you do not need any tool and you do not have to go through any cumbersome process that might be very inconvenient while you are in the field.



SECOND FOCAL PLANE



IDEAL FOR LONG DISTANCE SHOOTING



30MM TUBE DIAMETER

KONUSPRO EL-30



#7331 6x-24x50 ZOOM
10 INTERCHANGEABLE ILLUMINATED RETICLES

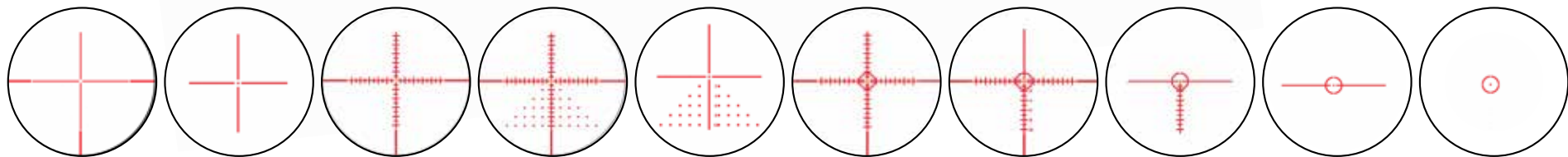

FEATURES

- › 6X-24X ZOOM POWER
- › ONE PIECE 30MM ALUMINUM TUBE
- › 10 INTERCHANGEABLE RETICLES
- › LOCKING TACTICAL TURRETS
- › 1/8 M.O.A. ADJUSTMENTS
- › WATERPROOF, FOGPROOF, SHOCKPROOF
- › FULLY MULTI-COATED OPTICS
- › PATENTED PARALLAX WHEEL THAT IS POSITIONED ON THE ZOOM RING
- › RED COLOUR ILLUMINATION

CODE	7331
MAGNIFICATION X OBJECTIVE DIAMETER	6-24X50 ZOOM
RETICLE	10 INTERCHANGEABLE RETICLES
FIELD OF VIEW (AT 100M/YDS)	5.6 M - 18.3 FT AT 6X 2 M - 6.5 FT AT 24X
WEIGHT (GR/OZ)	780 GR - 27.5 OZ
LENGTH (MM/INCHES)	399 MM - 15.7"
EYE RELIEF (MM/INCHES)	83.8 MM - 3.29" AT 6X 76.2MM-3" AT 24X
EXIT PUPIL (MM)	9 AT 6X - 8.2 AT 24X
CLICK VALUE (AT 100M/YDS)	1/8 M.O.A.
ADJUSTING RANGE (AT 100M/YDS)	30 MM - 1.18"
MOUNTING LENGTH (MM/INCHES)	165 MM - 6.49"

10 INTERCHANGEABLE RETICLES WITH PATENTED LCD TECHNOLOGY

A worldwide exclusivity of Konus and the result of a decade long project of electronic engineering, this one-of-a-kind model is taking advantage of a patented LCD technology that will let you browse through 10 interchangeable reticles for long range shooting, intermediate use, tactical and hunting. This is therefore the most technologically advanced and the most versatile scope in the market, a true quantum leap that is finally bringing the optical industry into the 21st Century.

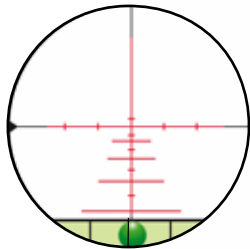

#7178 5x-40x56 ZOOM
EXTRA THIN 550 BALLISTIC RETICLE
WITH DUAL ILLUMINATION
(RED - BLUE)

FEATURES

- › ED GLASS
- › 30MM TUBE
- › CONSTANT LONG EYE RELIEF AT ALL MAGNIFICATIONS
- › COMPACT DESIGN WITH WIDE FIELD OF VIEW
- › SIDE PARALLAX WHEEL
- › EXCEPTIONAL OPTICAL PERFORMANCE WITH DISTORTION-FREE RESOLUTION
- › ULTRA WHITE BAND FULLY MULTI-COATING FOR HIGH TRANSMISSION AND INCREDIBLE CLARITY
- › HYDROPHOBIC LENS COATING SUITABLE FOR RAINY DAYS
- › HIGH PRECISION LOCKING TACTICAL TURRETS
- › SUNSHADED INCLUDED
- › ENGRAVED AND EXTRA THIN RETICLE

CODE	7178
MAGNIFICATION X OBJECTIVE DIAMETER	5-40X56 ZOOM
RETICLE	EXTRA THIN 550 BALLISTIC RETICLE
FIELD OF VIEW (AT 100M/YDS)	7.3 M - 24 FT AT 5X 0.9 M - 3 FT AT 40X
WEIGHT (GR/OZ)	800 GR - 28.2 OZ
LENGTH (MM/INCHES)	401.5 MM - 15.8"
EYE RELIEF (MM/INCHES)	91MM - 3.5" AT 5X 92MM - 3.6" AT 40X
EXIT PUPIL (MM)	8 AT 5X - 1.4 AT 40X
CLICK VALUE (AT 100M/YDS)	1/8 M.O.A.
ADJUSTING RANGE (AT 100M/YDS)	60 M.O.A.
MOUNTING LENGTH (MM/INCHES)	182.8 MM - 7.19"

THE ED GLASS ADVANTAGE

Engineered to maximize light transmission and reduce chromatic aberration, this riflescope will provide competitive shooters with what they need most: an enormous magnification range that goes from 5x to 40x, coupled with the breath-taking sharpness and contrast of the finest ED glass. The result is a dream come true in terms of unparalleled versatility and flawless on-field performance, especially when shooting at supremely long distances. Its exclusive 550-ballistic reticle has been made especially thin to avoid impairing the target acquisition, while also being dual illuminated and laser-etched.



SECOND FOCAL PLANE



IDEAL FOR LONG DISTANCE SHOOTING



30MM TUBE DIAMETER

ABSOLUTE

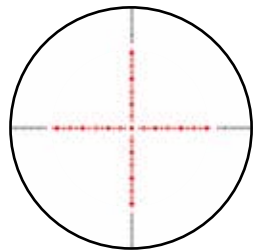

#7179 5x-40x56 ZOOM
MODIFIED HALF MIL-DOT RETICLE
WITH DUAL ILLUMINATION
(RED - BLUE)

FEATURES

- › ED GLASS
- › 30MM TUBE
- › CONSTANT LONG EYE RELIEF AT ALL MAGNIFICATIONS
- › COMPACT DESIGN WITH WIDE FIELD OF VIEW
- › SIDE PARALLAX WHEEL
- › EXCEPTIONAL OPTICAL PERFORMANCE WITH DISTORTION-FREE RESOLUTION
- › ULTRA WHITE BAND FULLY MULTI-COATING FOR HIGH TRANSMISSION AND INCREDIBLE CLARITY
- › HYDROPHOBIC LENS COATING SUITABLE FOR RAINY DAYS
- › HIGH PRECISION LOCKING TACTICAL TURRETS
- › SUNSHADED INCLUDED
- › ENGRAVED RETICLE

CODE	7179
MAGNIFICATION X OBJECTIVE DIAMETER	5-40X56 ZOOM
RETICLE	MODIFIED HALF MIL DOT
FIELD OF VIEW (AT 100M/YDS)	7.3 M - 24FT AT 5X 0.9 M - 3FT AT 40X
WEIGHT (GR/OZ)	800 GR - 28.2 OZ
LENGTH (MM/INCHES)	401.5 MM - 15.8"
EYE RELIEF (MM/INCHES)	91MM - 3.5" AT 5X 92MM - 2.6" AT 40X
EXIT PUPIL (MM)	8 AT 5X - 1.4 AT 40X
CLICK VALUE (AT 100M/YDS)	1/10 MIL
ADJUSTING RANGE (AT 100M/YDS)	48 M.O.A.
MOUNTING LENGTH (MM/INCHES)	182.8 MM - 7.19"

THE ED GLASS ADVANTAGE

Superb light transmission. Impeccable sharpness and clarity. Excellent image quality with unbelievable contrast at the highest magnifications. These are the main traits of the superior ED glass and in the past you would have had to pay a hefty price for that.

Not anymore: our #7179 model is supremely affordable and is therefore a dream come true for long distance shooters, by virtue of its huge 5x - 40x zoom power to go along with an array of truly incomparable features.

KONUSPRO NV-3

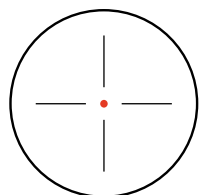
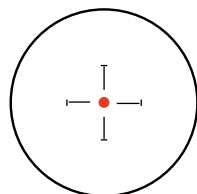
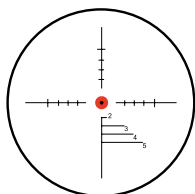
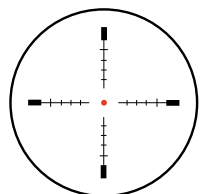
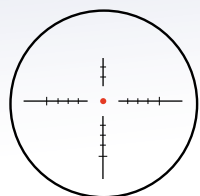

#7872 3x-9x32 ZOOM
5 INTERCHANGEABLE RETICLES
IN 5 COLORS
(BLACK - BLUE - RED - GREEN - WHITE)



FEATURES

- › 3-9X32 DIGITAL NIGHT VISION RIFLESCOPE
- › 1/2 M.O.A. ADJUSTMENTS
- › QUICK RELEASE MOUNT SUITABLE FOR WEAVER/PICATINNY RAILS
- › DAYTIME AND NIGHTTIME MODE
- › 4 PALETTES: COLOR - B/W - SEPHIA - GREEN
- › REMOVABLE ZOOM ILLUMINATOR FOR TOTAL DARKNESS
- › PHOTO/VIDEO RECORDING FUNCTION
- › DAYLIGHT VISION FILTER
- › SUPPLIED WITH USB CABLE AND TWO RECHARGEABLE 18650 AND ICR18350 BATTERIES
- › 8GB INTERNAL MEMORY MODULE

CODE	7872
MAGNIFICATION X OBJECTIVE DIAMETER	3-9X32 ZOOM
RETICLE	5 SELECTABLE RETICLES IN 5 COLORS
FIELD OF VIEW (AT 100M/YDS)	14M 45.9FT
WEIGHT (GR/OZ)	275GR - 9.7OZ
LENGTH (MM/INCHES)	150MM - 5.9"
CLICK VALUE (AT 100M/YDS)	1/2 M.O.A.
ADJUSTING RANGE (AT 100M/YDS)	60 M.O.A. ELEVATION 80 M.O.A. WINDAGE
MOUNTING LENGTH (MM/INCHES)	80MM

SUPER COMPACT NIGHT VISION RIFLESCOPE

Night Vision technology has never been so portable (5.9" - 15cm) and lightweight (9.7OZ - 275g). This digital rifle scope is therefore in a class of its own, especially because it also comes with an array of very special features: 5 interchangeable reticles in 5 colors, 4 palettes, daylight vision filter and removable zoom illuminator for total darkness. Ideal for both daytime and nighttime, this model is also equipped with a quick release mounting system for Weaver/Picatinny rails. Finally, its photo/video recording function gives you the opportunity of documenting your observations.



SECOND FOCAL PLANE



IDEAL FOR LONG DISTANCE SHOOTING



30MM TUBE DIAMETER



ARMADA



#7165 4x-16x50 ZOOM
GERMAN-4 RETICLE
WITH DUAL ILLUMINATION
(RED - BLUE)

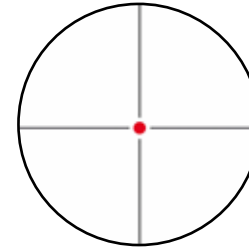

#7166 6x-25x56 ZOOM
FINE CROSSHAIR RETICLE
WITH DUAL ILLUMINATED DOT
(RED - BLUE)

FEATURES

- › 30MM TUBE
- › ENGRAVED RETICLE WITH DUAL ILLUMINATION
- › LOCKING TURRETS (PUSH-PULL)
- › FULLY MULTI-COATED OPTICS
- › FAST FOCUS OCULAR
- › WATERPROOF, SHOCKPROOF, FOGPROOF
- › PATENTED PARALLAX WHEEL FOR SUPREMELY ACCURATE MEASUREMENTS OF SHOOTING DISTANCE
- › ANTI-CANTING BUBBLE LEVEL

CODE	7165	7166
MAGNIFICATION X OBJECTIVE DIAMETER	4-16X50	6-24X56 ZOOM
RETICLE	DUAL ILLUMINATED GERMAN-4	FINE CROSSHAIR W/DUAL ILL. DOT
FIELD OF VIEW (AT 100M/YDS)	6.7M-21.9FT AT 4X 2.3M-7.8FT AT 16X	5.2M-17.2FT AT 6X 1.7M-5.7 FT AT 24X
WEIGHT (GR/OZ)	746 GR - 26.3 OZ	855 GR - 30.1 OZ
LENGTH (MM/INCHES)	380 MM - 14.9"	420 MM - 16.5"
EYE RELIEF (MM/INCHES)	80MM - 3.14" AT 4X 66MM - 2.59" AT 6X	72MM - 2.8" AT 6X 63MM - 2.4" AT 24X
EXIT PUPIL (MM)	13.5 AT 4X 6.6 AT 16X	10.5 AT 6X 5.3 AT 24X
CLICK VALUE (AT 100M/YDS)	1/4 M.O.A.	1/8 M.O.A.
ADJUSTING RANGE (AT 100M/YDS)	56 M.O.A.	52 M.O.A.
MOUNTING LENGTH (MM/INCHES)	80 MM - 3.14"	80 MM - 3.14"

REINVENTING THE PARALLAX WHEEL

Chock-full of advanced and professional features, the Armada models are especially notable for their revolutionary parallax system that delivers incomparable accuracy by virtue of its exclusive and patented technology. While the average parallax wheel will simply provide an estimation about a given distance (200m/yds will be anything between 190m/yds and 210 m/yds) the exclusive system of the Armada models in spot-on and flawless with every single measurement instead (200 m/yds will be 200 m/yds with the same precision of a laser rangefinder).



#7188 2x-16x50 ZOOM
GERMAN-4 RETICLE WITH DUAL ILLUMINATION (RED - BLUE)

#7189 3x-24x56 ZOOM
FINE CROSSHAIR RETICLE WITH DUAL ILLUMINATION (RED-BLUE)

FEATURES

- › LOCKING TURRETS (PUSH/PULL) RESETTABLE TO ZERO
- › CONSTANT LONG EYE RELIEF AT ALL MAGNIFICATIONS
- › NEWLY DESIGNED ERECTOR TUBE SYSTEM FOR INCREASED RELIABILITY UNDER HEAVY RECOIL FORCE
- › SIDE PARALLAX WHEEL
- › FULLY MULTI-COATING WITH ULTRA-WIDE BAND FOR IMPROVED LIGHT TRANSMISSION AND INCREDIBLE CLARITY
- › EXTREMELY WIDE FIELD OF VIEW
- › REMOVABLE ZOOM LEVER AND SUNSHADE

CODE	7188	7189
MAGNIFICATION X OBJECTIVE DIAMETER	2-16X50 ZOOM	3-24X56 ZOOM
RETICLE	ILLUMINATED GERMAN-4	ILLUMINATED FINE CROSSHAIR
FIELD OF VIEW (AT 100M/YDS)	17.3M-56.9FT AT 2X 2.3M-7MT AT 16X	11.4M-37.6FT AT 3X 1.4M - 4.8FT AT 24X
WEIGHT (GR/OZ)	708 GR - 25 OZ	765 GR - 25.6 OZ
LENGTH (MM/INCHES)	342MM - 13.5"	381MM - 15"
EYE RELIEF (MM/INCHES)	95.7MM - 3.77" AT 2X 94.9MM - 3.74" AT 16X	96MM - 3.77" AT 3X 94MM - 3.74" AT 24X
EXIT PUPIL (MM)	7.9 AT 2X 3.2 AT 16X	7.8 AT 3X 2.3 AT 24X
CLICK VALUE (AT 100M/YDS)	1/4 M.O.A.	1/8 M.O.A.
ADJUSTING RANGE (AT 100M/YDS)	2.28M - 90"	1.77M - 70"
MOUNTING LENGTH (MM/INCHES)	148MM - 5.8"	165MM - 6.4"

THE CHOICE OF THE MOST ACCOMPLISHED HUNTERS AND SHOOTERS

Two truly all-around riflescopes that will prove to be ideal for countless shooting scenarios, thanks to their 8x zoom system that will assist you flawlessly at both short range and long distance. Optically and mechanically, they are in a league of their own by virtue of their special and superior features that will easily outclass every competing model out there.



SECOND FOCAL PLANE



IDEAL FOR LONG DISTANCE SHOOTING



30 MM TUBE DIAMETER

DIABLO



#7172 4x-16x50 ZOOM
550-BALLISTIC RETICLE WITH DUAL ILLUMINATION (RED - BLUE)

#7173 6x-24x50 ZOOM
MODIFIED 1/2 MIL-DOT RETICLE WITH DUAL ILLUMINATION (RED - BLUE)

FEATURES

- › EXTREMELY WIDE FIELD OF VIEW
- › 30MM TUBE
- › SIDE PARALLAX WHEEL
- › ENGRAVED RETICLE
- › ULTRA WIDE BAND FULLY MULTI-COATING FOR INCREASED TRANSMISSION AND BETTER CLARITY
- › HYDROPHOBIC LENS COATING SUITABLE FOR RAINY DAYS
- › EXTREMELY ACCURATE MAGNIFICATION FOR ACCURATE BALLISTIC TRAJECTORY
- › NEWLY DESIGNED ERECTOR TUBE SYSTEM FOR INCREASED RELIABILITY UNDER HEAVY RECOIL FORCE
- › SUNSHADE INCLUDED

CODE	7172	7173
MAGNIFICATION X OBJECTIVE DIAMETER	4-16X50 ZOOM	6-24X50 ZOOM
RETICLE	ILLUMINATED 550 BALLISTIC	ILLUMINATED 1/2 MIL-DOT
FIELD OF VIEW (AT 100M/YDS)	9.2M-30.24FT AT 4X 2.4M-7.9FT AT 16X	6.4M-21FT AT 6X 1.74M-5.7FT AT 24X
WEIGHT (GR/OZ)	680 GR - 23.9 OZ	726 GR - 25.6 OZ
LENGTH (MM/INCHES)	342.9 MM - 13.5"	386.08 MM - 15.2"
EYE RELIEF (MM/INCHES)	81.28 MM - 3.2"	81.28 MM - 3.2"
EXIT PUPIL (MM)	9.8 AT 4X 3 AT 16X	7.3 AT 6X 2.2 AT 24X
CLICK VALUE (AT 100M/YDS)	1/4 M.O.A.	1/10 MIL (10MM)
ADJUSTING RANGE (AT 100M/YDS)	1.69 M 66.53"	1.35 M 53.14"
MOUNTING LENGTH (MM/INCHES)	149 MM 5.8"	173 MM 6.8"

THE RIFLESCOPES THAT MAXIMIZE PERFORMANCE AND VALUE

These riflescopes are designed for utmost versatility across multiple shooting disciplines and are especially suitable for varmint hunting and target shooting.

Taking into account their mechanical reliability and optical brilliance, they are offered at an unprecedented price level and are therefore an ideal solution for sportsmen on a budget.

KONUSPRO-M30



SECOND FOCAL PLANE



IDEAL FOR HUNTING



30MM TUBE DIAMETER

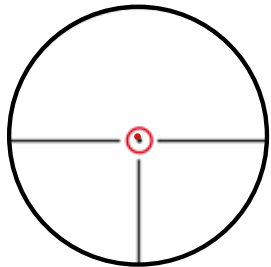

#7182 1x-6x24 ZOOM

ENGRAVED CIRCLE-DOT
RETICLE WITH DUAL ILLUMINATION
(RED - BLUE)

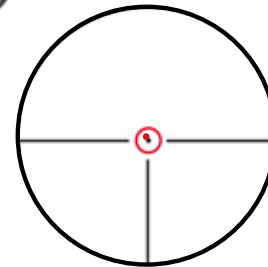

#7184 1x-4x24 ZOOM

ENGRAVED CIRCLE-DOT
RETICLE WITH DUAL ILLUMINATION
(RED - BLUE)

FEATURES

- › ENGRAVED RETICLE WITH DUAL ILLUMINATION
- › FINGER ADJUSTABLE TACTICAL TURRETS
- › PRECISION 1/2 M.O.A. ADJUSTMENTS
- › FULLY MULTI-COATED OPTICS
- › FAST FOCUS OCULAR
- › WATERPROOF, SHOCKPROOF, FOGPROOF

CODE	7182	7184
MAGNIFICATION X OBJECTIVE DIAMETER	1-6X24 ZOOM	1-4X24 ZOOM
RETICLE	ILLUMINATED CIRCLE-DOT	ILLUMINATED CIRCLE-DOT
FIELD OF VIEW (AT 100M/YDS)	36M - 109FT AT 1X 5.5M - 16.7FT AT 6X	30.6M - 100FT AT 1X 7.6M - 25FT AT 4X
WEIGHT (GR/OZ)	485 GR - 17.1 OZ	500 GR - 17.6 OZ
LENGTH (MM/INCHES)	247 MM - 9.72"	294 MM - 11.6"
EYE RELIEF (MM/INCHES)	103MM - 4.05" AT 1X 93MM - 3" AT 6X	101 MM - 3.9" AT 1X 90MM - 3.5" AT 4X
EXIT PUPIL (MM)	11 AT 1X 4 AT 6X	12 AT 1X 6 AT 4X
CLICK VALUE (AT 100M/YDS)	1/2 M.O.A.	1/2 M.O.A.
ADJUSTING RANGE (AT 100M/YDS)	2.9 M - 114.1"	2.7 M - 110"
MOUNTING LENGTH (MM/INCHES)	150 MM - 5.9"	150 MM - 5.9"

IDEAL FOR SHOOTING AT SHORT/MEDIUM RANGE

These models will deliver an impeccable and rewarding performance on countless types of hunt and even in the faintest light conditions. They are especially suitable for shooting at close and medium distance or aiming at fast moving targets.



SECOND FOCAL PLANE



IDEAL FOR TACTICAL USE



34MM TUBE DIAMETER

KONUSPRO AS-34

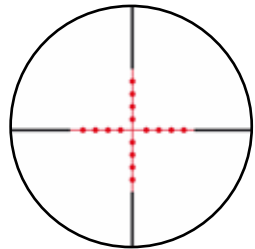

#7170 2x-6x28 ZOOM

ENGRAVED MIL-DOT RETICLE WITH DUAL ILLUMINATION (RED - GREEN)

FEATURES

- › WATERPROOF, FOGPROOF, SHOCKPROOF
- › NITROGEN FILLED
- › WIDE ANGLE
- › FAST FOCUS OCULAR
- › FULLY MULTI-COATED OPTICS
- › ENGRAVED RETICLE IN THE SECOND FOCAL PLANE WITH RED/GREEN ILLUMINATION
- › LOCKING TACTICAL TURRETS
- › DUAL ILLUMINATOR SWITCH WITH 5 BRIGHTNESS SETTINGS
- › 34MM TUBE DIAMETER
- › ILLUMINATED LEVEL BUBBLE
- › PRECISION 1/4 M.O.A. ADJUSTMENTS

CODE	7170
MAGNIFICATION X OBJECTIVE DIAMETER	2-6X28 ZOOM
RETICLE	ILLUMINATED MIL-DOT
FIELD OF VIEW (AT 100M/YDS)	18 M - 54 FT AT 2X 7.3 M - 22 FT AT 6X
WEIGHT (GR/OZ)	560 GR - 19.75 OZ
LENGTH (MM/INCHES)	212 MM - 8.35"
EYE RELIEF (MM/INCHES)	122 MM-4.8" AT 2X 104MM - 4.09" AT 6X
EXIT PUPIL (MM)	14 AT 2X - 4.7 AT 6X
CLICK VALUE (AT 100M/YDS)	1/4 M.O.A.
ADJUSTING RANGE (AT 100M/YDS)	2.67 M - 105.1"
MOUNTING LENGTH (MM/INCHES)	68 MM - 2.677"

ELECTRONIC TACTICAL SCOPE

The Konuspro AS-34 has been constructed with quick target acquiring properties. Speed and accuracy have therefore been enhanced, whether at the range or in close quarter combat situations. A beefy outer diameter of 34mm will withstand the most extreme conditions, while an integrated tri-rail system will accept all of your accessories. Completely waterproof, this model features a dual illuminated Mil-Dot reticle an illuminated level bubble for low light shooting. The base is reversible and will fit both the Weaver/Picatinny and .22 rails, while the field of view is especially wide for fast moving targets.

KONUSPRO F-30



FIRST FOCAL PLANE



IDEAL FOR HUNTING



30MM TUBE DIAMETER

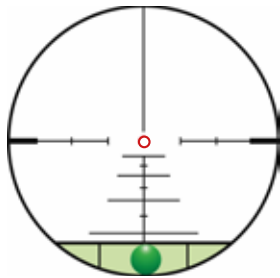

#7299 4x-16x52 ZOOM

550 BALLISTIC RETICLE WITH DUAL ILLUMINATED (RED - BLUE) CENTER CIRCLE

FEATURES

- › 550 BALLISTIC ENGRAVED RETICLE WITH RED/BLUE ILLUMINATED CIRCLE
- › FLIP-UP COVERS INCLUDED
- › SUNSHADE INCLUDED
- › LEVEL BUBBLE
- › WATERPROOF, FOGPROOF, SHOCKPROOF
- › NITROGEN FILLED
- › FULLY MULTI-COATED OPTICS
- › FAST FOCUS OCULAR
- › 45° OFFSET ILLUMINATOR SWITCH WITH 5 INTENSITIES FOR COLOR
- › MID-SIZED PARALLAX WHEEL (DOWN TO 10 YDS)
- › PRECISION 1/4 M.O.A. ADJUSTMENTS
- › 30 MM TUBE DIAMETER

CODE	7299
MAGNIFICATION X OBJECTIVE DIAMETER	4-16X52 ZOOM
RETICLE	550 BALLISTIC WITH ILLUMINATED CIRCLE
FIELD OF VIEW (AT 100M/YDS)	7.1 M - 23.1 FT AT 4X 1.9 M - 6.5 FT AT 16X
WEIGHT (GR/OZ)	780 GR - 27.5 OZ
LENGTH (MM/INCHES)	365 MM - 14.3"
EYE RELIEF (MM/INCHES)	88.9 MM - 3.5"
EXIT PUPIL (MM)	12.5 AT 4X 3.1 AT 16X
CLICK VALUE (AT 100M/YDS)	1/4 M.O.A.
ADJUSTING RANGE (AT 100M/YDS)	1.7 M - 67"
MOUNTING LENGTH (MM/INCHES)	151 MM - 5.9"

THE FIRST

FOCAL PLANE REVOLUTION

Konus is proud to introduce a revolutionary series of riflescopes featuring an engraved reticle on the first focal plane.

Highly appreciated by the marksmen of the most decorated military corps for its incomparable precision and ease of use, this particularly complex construction system is now more affordable than ever.



FIRST FOCAL PLANE



IDEAL FOR LONG DISTANCE SHOOTING



30MM TUBE DIAMETER

KONUSPRO F-30

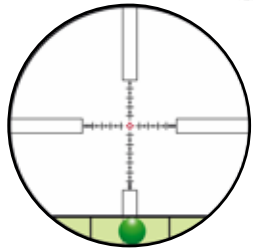

#7297 6x-24x52 ZOOM
1/2 MIL-DOT RETICLE WITH DUAL ILLUMINATED (RED-BLUE) CENTER CIRCLE

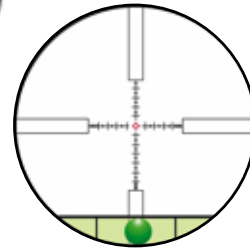

#7298 8x-32x56 ZOOM
1/2 MIL-DOT RETICLE WITH DUAL ILLUMINATED (RED-BLUE) CENTER CIRCLE

FEATURES

- › 1/2 MIL DOT ENGRAVED RETICLE
- › FLIP-UP COVERS INCLUDED
- › SUNSHADE INCLUDED
- › LEVEL BUBBLE
- › WATERPROOF, FOGPROOF, SHOCKPROOF
- › LOCKING TACTICAL TURRET KNOBS
- › NITROGEN FILLED
- › FAST FOCUS OCULAR
- › 45° OFFSET ILLUMINATOR SWITCH WITH 5 INTENSITIES FOR COLOR (RED/BLUE)
- › MID-SIZED PARALLAX WHEEL (DOWN TO 10 YARDS)
- › PRECISION 1/10 MIL ADJUSTMENTS
- › 30MM TUBE DIAMETER

CODE	7297	7298
MAGNIFICATION X OBJECTIVE DIAMETER	6-24X52 ZOOM	8-32X56 ZOOM
RETICLE	ILLUM. MODIFIED 1/2 MIL-DOT	ILLUM. MODIFIED 1/2 MIL-DOT
FIELD OF VIEW (AT 100M/YDS)	4.51M - 14.8FT AT 6X 1.3M - 4.3 FT AT 24X	3.81M - 12.1FT AT 8X 1.03M - 3.4FT AT 32X
WEIGHT (GR/OZ)	810 GR - 26.8 OZ	890 GR. - 31.4 OZ
LENGTH (MM/INCHES)	417 MM - 16.4"	444 MM - 17.5"
EYE RELIEF (MM/INCHES)	88.9 MM - 3.5"	88.9 MM - 3.5"
EXIT PUPIL (MM)	8.3 AT 6X 2.2 AT 24X	7 AT 8X 1.7 AT 32X
CLICK VALUE (AT 100M/YDS)	1/10 MIL	1/10 MIL
ADJUSTING RANGE (AT 100M/YDS)	1.47 M 58"	1.14 M 45"
MOUNTING LENGTH (MM/INCHES)	161 MM 6.4"	165 MM 6.5"

THE FIRST FOCAL PLANE REVOLUTION

Combining the utmost precision of the first focal plane construction system with a never-before-seen versatility, these brand new riflescopes are truly ideal for performance-driven long distance, target and bench-rest shooters.

KONUSPRO M-30



SECOND FOCAL PLANE



IDEAL FOR LONG DISTANCE SHOOTING



30MM TUBE DIAMETER

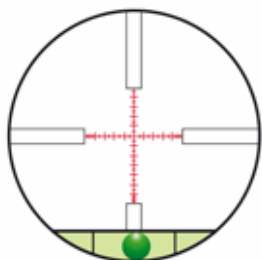

#7289 12.5x-50x56 ZOOM
ENGRAVED 1/2 MIL-DOT
WITH DUAL ILLUMINATION
(RED-BLUE)

FEATURES

- › FLIP-UP COVERS INCLUDED
- › SUNSHADE INCLUDED
- › LEVEL BUBBLE
- › 1/10 MIL ADJUSTMENTS
- › ONE-PIECE TUBE
- › LOCKING TACTICAL TURRET KNOBS
- › NITROGEN FILLED
- › MID-SIZED PARALLAX WHEEL
- › FULLY MULTI COATED OPTICS
- › LOCKING FAST FOCUS OCULAR
- › 30MM TUBE DIAMETER

CODE	7289
MAGNIFICATION X OBJECTIVE DIAMETER	12,5-50X56 ZOOM
RETICLE	1/2 MIL DOT ILLUMINATED
FIELD OF VIEW (AT 100M/YDS)	2.9 M - 9.7 FT AT 12.5X 0.7 M - 2.5 FT AT 50X
WEIGHT (GR/OZ)	870 GR - 30.6 OZ
LENGTH (MM/INCHES)	449 MM - 17.6"
EYE RELIEF (MM/INCHES)	76.2MM - 3" AT 12.5X 65MM - 2.5" AT 50X
EXIT PUPIL (MM)	4.4 AT 12.5X 1.15 AT 50X
CLICK VALUE (AT 100M/YDS)	1/10 MIL
ADJUSTING RANGE (AT 100M/YDS)	0.81 M 32"
MOUNTING LENGTH (MM/INCHES)	195 MM 7.6"

THE RIFLESCOPE IN A CLASS BY ITSELF

This supremely powerful model stands out as the best and ultimate rifle scope for long distance shooting, thus giving every demanding sportsman the chance to step on the field and successfully take even the most prohibitive shot.



SECOND FOCAL PLANE



IDEAL FOR HUNTING



30MM TUBE DIAMETER



WILD



#7354 3x-9x40 ZOOM
GERMAN-4 RETICLE

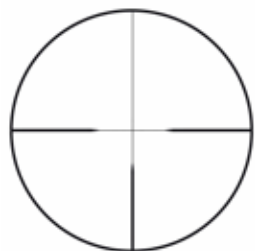

#7355 4x-12x40 ZOOM
GERMAN-4 RETICLE
WITH DUAL ILLUMINATION
(RED - GREEN)

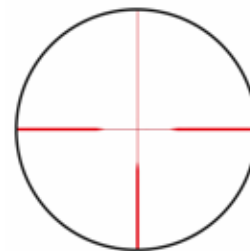

FEATURES

- › 30MM TUBE DIAMETER
- › LOCKING TACTICAL TURRETS, RESETTABLE TO ZERO
- › PRECISION 1/4 M.O.A ADJUSTMENTS
- › MULTI-COATED OPTICS
- › ADJUSTABLE OBJECTIVE (# 7355)
- › ILLUMINATED RETICLE (# 7355)
- › FLIP-UP COVERS INCLUDED
- › REMOVABLE ZOOM LEVER
- › FAST FOCUS OCULAR
- › WATERPROOF, SHOCKPROOF, FOGPROOF

CODE	7354	7355
MAGNIFICATION X OBJECTIVE DIAMETER	3-9X40 ZOOM	4-12X40 ZOOM
RETICLE	GERMAN-4	ILLUMINATED GERMAN-4
FIELD OF VIEW (AT 100M/YDS)	12.3M - 40.4FT AT 3X 4.11M - 13.5FT AT 9X	9.2M - 30.3FT AT 4X 3.07M - 10.1FT AT 12X
WEIGHT (GR/OZ)	440 GR - 15.5 OZ	560 GR - 19.7 OZ
LENGTH (MM/INCHES)	314 MM - 12.3"	350 MM - 13.77"
EYE RELIEF (MM/INCHES)	85MM - 3.34" AT 3X 95MM - 3.74" AT 9X	85MM - 3.34" AT 4X 95MM - 3.74" AT 12X
EXIT PUPIL (MM)	12 AT 3X 4.44 AT 9X	9 AT 4X 3.33 AT 12X
CLICK VALUE (AT 100M/YDS)	1/4 M.O.A.	1/4 M.O.A.
ADJUSTING RANGE (AT 100M/YDS)	1.74 M - 68,5"	1.74 M - 68,5"
MOUNTING LENGTH (MM/INCHES)	134.2 MM - 5.2"	142.6 MM - 5.6"

THE MOST AFFORDABLE 30MM RIFLESCOPES ON THE MARKET

Available in the highly popular 3-9x40 and 4-12x40 configurations, these models bring to the table an array of very special features at an unprecedented price.

Sportsmen that are tight on a budget will therefore be able to take advantage of some superior 30mm riflescopes that will vastly outperform any comparable 1" model out there.

The # 7355, in particular, is especially notable because it also comes with adjustable objective and dual illumination as an added value.

KONUSPRO LZ-30



SECOND FOCAL PLANE



IDEAL FOR HUNTING



30MM TUBE DIAMETER

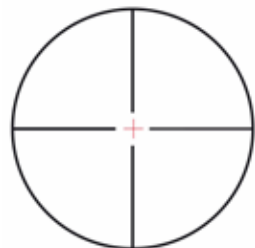

#7180 2.5x-10x50 ZOOM
30/30 RETICLE WITH DUAL ILLUMINATED FLOATING CROSS (RED-BLUE)



#7181 3x-12x56 ZOOM
30/30 RETICLE WITH DUAL ILLUMINATED FLOATING CROSS (RED-BLUE)

FEATURES

- › WATERPROOF/FOGPROOF/ SHOCKPROOF
- › EXTRA WIDE FIELD OF VIEW (20% WIDER THAN STANDARD MODELS)
- › FULLY MULTI-COATED OPTICS
- › PRECISION 1/4 M.O.A. ADJUSTMENTS
- › DUAL LOCKING TURRETS WITH ZERO-RESETTING BEZEL
- › 30/30 ENGRAVED RETICLE WITH FLOATING CROSS
- › DUAL ILLUMINATION (RED/BLUE)
- › ONE PIECE TUBE CONSTRUCTION
- › FAST FOCUS OCULAR

CODE	7180	7181
MAGNIFICATION X OBJECTIVE DIAMETER	2.5-10X50 ZOOM	3-12X56 ZOOM
RETICLE	30/30 ILLUM. FLOATING CROSS	30/30 ILLUM. FLOATING CROSS
FIELD OF VIEW (AT 100M/YDS)	15.4M - 50.8FT AT 2.5X 3.8M - 12.7FT AT 10X	13M - 42.8FT AT 3X 3.2M - 10.7FT AT 12X
WEIGHT (GR/OZ)	640 GR - 22.58 OZ	720 GR - 25.4 OZ
LENGTH (MM/INCHES)	328 MM - 12.9"	340 MM - 13.4"
EYE RELIEF (MM/INCHES)	83.82 MM 3.3"	83.82 MM 3.3"
EXIT PUPIL (MM)	20 AT 2.5X 5 AT 10X	18.6 AT 3X 4.6 AT 12X
CLICK VALUE (AT 100M/YDS)	1/4 M.O.A.	1/4 M.O.A.
ADJUSTING RANGE (AT 100M/YDS)	1.52 M - 60"	1.52 M - 60"
MOUNTING LENGTH (MM/INCHES)	141 MM - 5.55"	144 MM - 5.67"

RIFLESCOPES WITH DUAL-ZERO LOCKING SYSTEM

The Konuspro LZ-30 series of riflescopes features an advanced, dual locking system that is designed to lock-in your final adjustments and reset your bezel to zero with utmost precision. Its one-piece 30mm tube is unbelievably rugged, while its fully multi-coated high quality glass is able to generate the maximum light transmission under the most unfavorable conditions. The unique 30/30 reticle with floating cross is etched for supreme recoil resistance and is also dual-illuminated in red and blue. The field of view is extremely generous, being 20% wider than the other comparable models that are currently on the market.



SECOND FOCAL PLANE



IDEAL FOR TACTICAL USE



30MM TUBE DIAMETER

KONUSPRO T-30

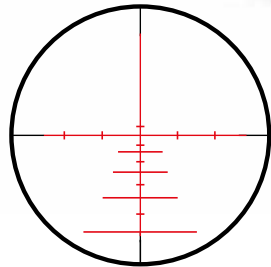

#7291 3x-12x44 ZOOM
ENGRAVED 550 BALLISTIC WITH DUAL ILLUMINATION (RED-BLUE)

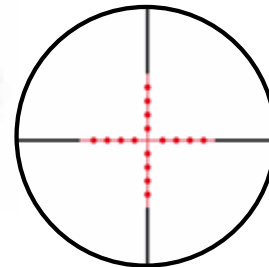

#7292 3x-12x50 ZOOM
MIL-DOT ENGRAVED RETICLE WITH DUAL ILLUMINATION (RED-BLUE)

FEATURES

- › WATERPROOF, FOGPROOF, SHOCKPROOF
- › NITROGEN FILLED
- › FULLY MULTI COATED OPTICS
- › FLIP-UP COVERS INCLUDED
- › 30MM TUBE (THROUGHOUT)
- › ONE PIECE TUBE CONSTRUCTION
- › FULLY ILLUMINATED RETICLE IN DUAL COLOR (RED/BLUE)
- › SUPER COMPACT BODY
- › PRECISION 1/4 M.O.A. ADJUSTMENTS

CODE	7291	7292
MAGNIFICATION X OBJECTIVE DIAMETER	3-12X44 ZOOM	3-12X50 ZOOM
RETICLE	BALLISTIC 550 ILLUMINATED	ILLUMINATED MIL-DOT
FIELD OF VIEW (AT 100M/YDS)	11.1 M - 36.7 FT AT 3X 2.7M - 9.1 FT AT 12X	7M - 22.9 FT AT 3X 1.75M - 5.7 FT AT 12X
WEIGHT (GR/OZ)	576 GR - 20.3 OZ	576 GR - 20.3 OZ
LENGTH (MM/INCHES)	252 MM - 9.92"	252 MM - 9.92"
EYE RELIEF (MM/INCHES)	90 MM - 3.54"	90 MM - 3.54"
EXIT PUPIL (MM)	9.4 AT 3X 3.7 AT 12X	11 AT 3X 2.7 AT 12X
CLICK VALUE (AT 100M/YDS)	1/4 M.O.A	1/4 M.O.A
ADJUSTING RANGE (AT 100M/YDS)	2.54 M - 100"	2.54 M - 100"
MOUNTING LENGTH (MM/INCHES)	90 MM - 3.5"	88 MM - 3.4"

THE SUPER COMPACT RIFLESCOPES FOR THE TACTICAL INDUSTRY

A highly innovative concept in the shooting industry, our Konuspro-T30 series features the same impeccable optical quality of our acclaimed Konuspro-M30 models in a much more compact configuration that is an ideal fit for the very demanding tactical field.

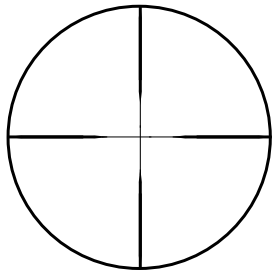

#7352 3x-9x40 ZOOM
30/30 RETICLE

FEATURES

- › METAL CONSTRUCTION
- › 30/30 RETICLE
- › MULTI-COATED OPTICS
- › INCLUDES MOUNTING RINGS FOR WEAVER/PICATINNY RAILS
- › FINGER ADJUSTABLE TURRETS
- › PRECISION 1/4 M.O.A. ADJUSTMENTS
- › FAST FOCUS OCULAR
- › WATERPROOF, FOGPROOF, SHOCKPROOF

CODE	7352
MAGNIFICATION X OBJECTIVE DIAMETER	3-9X40
RETICLE	30/30
FIELD OF VIEW (AT 100M/YDS)	10.9 M - 36 FT AT 3X 3.6 M - 12 FT AT 9X
WEIGHT (GR/OZ)	402G - 14.18 OZ
LENGTH (MM/INCHES)	320MM - 12.59"
EYE RELIEF (MM/INCHES)	95.25MM - 3.75"
EXIT PUPIL (MM)	12 AT 3X 4.4 AT 9X
CLICK VALUE (AT 100M/YDS)	1/4 M.O.A.
ADJUSTING RANGE (AT 100M/YDS)	80 M.O.A.
MOUNTING LENGTH (MM/INCHES)	154MM - 6.06"

BEST VALUE FOR THE MONEY

A combination of never-before-seen affordability that pairs a 3-9x40 rifle scope with a set of mounting rings for Weaver/Picatinny rails. Although being offered at an unbeatable price, this model features a nice optical quality to go along with full metal body and fast focus ocular. The reticle is the immensely popular 30/30 type, a truly ideal fit for countless hunting scenarios.



SECOND FOCAL PLANE



IDEAL FOR HUNTING



1" TUBE DIAMETER



FIGHTER

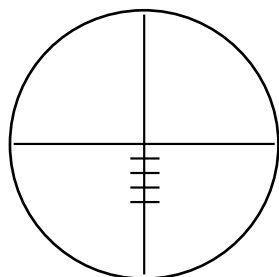

#7353 4x-12x40 A.O.
BALLISTIC RETICLE

FEATURES

- › METAL CONSTRUCTION
- › BALLISTIC RETICLE
- › MULTI-COATED OPTICS
- › INCLUDES MOUNTING RINGS FOR WEAVER/PICATINNY RAILS
- › FINGER ADJUSTABLE TURRETS
- › PRECISION 1/4 M.O.A. ADJUSTMENTS
- › FAST FOCUS OCULAR
- › WATERPROOF, FOGPROOF, SHOCKPROOF
- › ADJUSTABLE OBJECTIVE

CODE	7353
MAGNIFICATION X OBJECTIVE DIAMETER	4-12X40
RETICLE	BALLISTIC
FIELD OF VIEW (AT 100M/YDS)	9.4 M - 31 FT AT 4X 3.35 M - 11 FT AT 12X
WEIGHT (GR/OZ)	582G 20.56 OZ
LENGTH (MM/INCHES)	344MM - 13.54"
EYE RELIEF (MM/INCHES)	101.6MM - 4"
EXIT PUPIL (MM)	10 AT 4X 3.3 AT 12X
CLICK VALUE (AT 100M/YDS)	1/4 M.O.A.
ADJUSTING RANGE (AT 100M/YDS)	60 M.O.A.
MOUNTING LENGTH (MM/INCHES)	154MM - 6.06"

BEST VALUE FOR THE MONEY

A combination of never-before-seen affordability that pairs a 4-12x40 rifle scope with a set of mounting rings for Weaver/Picatinny rails. Although being offered at an unbeatable price, this model features a nice optical quality to go along with full metal body and fast focus ocular. On top of that, it also comes with adjustable objective and ballistic reticle for optimal long-distance shooting.

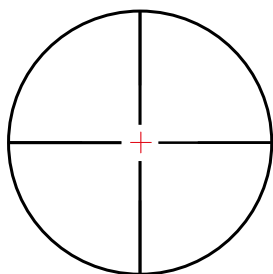

#7190 3x-12x50 ZOOM
30/30 RETICLE WITH DUAL ILLUMINATED FLOATING CROSS (RED-BLUE)

FEATURES

- › 3X-12X ZOOM POWER
- › 50MM OBJECTIVE DIAMETER
- › SUNSHADE INCLUDED
- › SIDE PARALLAX ADJUSTING KNOB
- › LOW PROFILE TACTICAL TURRETS
- › ONE PIECE ALUMINUM TUBE
- › 1/4 M.O.A. ADJUSTMENTS
- › WATERPROOF, FOGPROOF SHOCKPROOF
- › FULLY MULTI-COATED OPTICS
- › ENGRAVED RETICLE WITH DUAL ILLUMINATION (RED-BLUE)

CODE	7190
MAGNIFICATION X OBJECTIVE DIAMETER	3-12X50 ZOOM
RETICLE	30/30 ILLUMINATED FLOATING CROSS
FIELD OF VIEW (AT 100M/YDS)	9.6 M - 31.53 FT AT 3X 2.8 M - 9.43 FT AT 12X
WEIGHT (GR/OZ)	940 GR - 33.1 OZ
LENGTH (MM/INCHES)	335MM - 13.1"
EYE RELIEF (MM/INCHES)	72.3MM - 2.85"
EXIT PUPIL (MM)	5 AT 3X 2.6 AT 12X
CLICK VALUE (AT 100M/YDS)	1/4 M.O.A
ADJUSTING RANGE (AT 100M/YDS)	2,32 M - 91.3"
MOUNTING LENGTH (MM/INCHES)	135 MM - 5.31"

THE IDEAL HUNTING RIFLESCOPE

This model is tailor-made for countless types of game, by virtue of its fully multi-coated optics, side parallax knob and engraved/illuminated reticle. It comes with newly-designed low profile turrets and with a field of view that is extremely generous, being 20% wider than the other comparable models that are currently on the market.



SECOND FOCAL PLANE



IDEAL FOR LONG DISTANCE SHOOTING



1" TUBE DIAMETER

KONUSPRO-PLUS

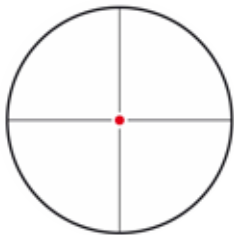

#7274 6x-24x50 A.O.
ENGRAVED FINE CROSSHAIR
WITH DUAL ILLUMINATED DOT
(RED-BLUE)

FEATURES

- › SUNSHADE INCLUDED
- › ADJUSTABLE OBJECTIVE
- › FINE CROSSHAIR WITH ILLUMINATED DOT
- › NEW FINGER ADJUSTABLE TACTICAL TURRETS
- › WATERPROOF, FOGPROOF, SHOCKPROOF
- › OPTICAL COATING: FULLY MULTI COATED
- › ILLUMINATED WITH 5 DIFFERENT INTENSITIES FOR EACH COLOR
- › PRECISION 1/8 M.O.A. ADJUSTMENTS

CODE	7274
MAGNIFICATION X OBJECTIVE DIAMETER	6-24X50 A.O.
RETICLE	ILLUMINATED FINE CROSSHAIR
FIELD OF VIEW (AT 100M/YDS)	5.41 M - 16.2 FT AT 6X 1.48 M - 4.45 FT AT 24X
WEIGHT (GR/OZ)	799 GR - 28.2 OZ
LENGTH (MM/INCHES)	416 MM - 16.4"
EYE RELIEF (MM/INCHES)	89 MM - 3.4"
EXIT PUPIL (MM)	8.3 AT 6X 2.1 AT 24X
CLICK VALUE (AT 100M/YDS)	1/8 M.O.A.
ADJUSTING RANGE (AT 100M/YDS)	1.16 M - 41.8"
MOUNTING LENGTH (MM/INCHES)	157 MM - 6.18"

HIGH END OPTICS FOR THE PROFESSIONALS

This model is an invaluable companion for varmint hunters and long distance shooters, thanks to its precision 1/8 M.O.A. adjustments coupled with a fine crosshair reticle.

KONUSPRO 550



SECOND FOCAL PLANE



IDEAL FOR LONG DISTANCE SHOOTING



1" TUBE DIAMETER



#7275 3x-9x40 ZOOM
ENGRAVED 550
BALLISTIC RETICLE



#7277 4x-16x50 A.O.
ENGRAVED 550
BALLISTIC RETICLE



#7276 3x-9x40 ZOOM
ENGRAVED 550 BALLISTIC RETICLE
WITH DUAL ILLUMINATED DOT
(RED-BLUE)

FEATURES

- › ENGRAVED 550 RETICLE
- › ENGRAVED 550 RETICLE WITH ILLUMINATED DOT IN RED AND BLUE (#7276)
- › ADJUSTABLE OBJECTIVE (#7277)
- › WATERPROOF, FOGPROOF, SHOCKPROOF
- › MULTI COATED OPTICS
- › FINGER ADJUSTABLE TURRETS
- › NITROGEN PURGED 100%
- › PRECISION 1/4 M.O.A. ADJUSTMENTS (#7275-76)
- › PRECISION 1/8 S ADJUSTMENTS (#7277)

CODE	7275	7276	7277
MAGNIFICATION X OBJECTIVE DIAMETER	3-9X40 ZOOM	3-9X40 ZOOM	4-16X50 A.O.
RETICLE	550 BALLISTIC	550 BALLISTIC WITH ILLUM. DOT	550 BALLISTIC
FIELD OF VIEW (AT 100M/YDS)	12.3M - 37FT AT 3X 4.1M - 12.3FT AT 9X	12.3M - 37FT AT 3X 4.1M - 12.3FT AT 9X	7.83M - 23.4FT AT 4X 1.95M - 5.87FT AT 16X
WEIGHT (GR/OZ)	399 GR 14.1 OZ	420 GR 14.8 OZ	697 GR 24.6 OZ
LENGTH (MM/INCHES)	320MM - 12.5"	320MM - 12.5"	406 MM - 16"
EYE RELIEF (MM/INCHES)	76 MM 2.9"	76 MM 2.9"	76 MM 2.9"
EXIT PUPIL (MM)	10 AT 3X 4.4 AT 9X	10 AT 3X 4.4 AT 9X	10 AT 4X 3.1 AT 16X
CLICK VALUE (AT 100M/YDS)	1/4 M.O.A	1/4 M.O.A.	1/8 M.O.A.
ADJUSTING RANGE (AT 100M/YDS)	1.3 M 51.1"	1.3 M 51.1"	1.7 M 66.9"
MOUNTING LENGTH (MM/INCHES)	141 MM 5.5"	141 MM 5.5"	152 MM 5.9"

A SPECIAL BALLISTIC RETICLE FOR LONG DISTANCE SHOOTING

The purpose of this reticle is to sensibly extend your range and improve your accuracy while taking the most difficult shots, because this reticle provides you with several aiming points that correspond to different distances and are based on the most popular centerfire and black powder loads. Due to its lateral hash marks, this reticle also allows for compensation in case of strong crosswinds.



SECOND FOCAL PLANE



IDEAL FOR HUNTING



1" TUBE DIAMETER

KONUSPRO 275



#7278 3x-9x40 ZOOM
ENGRAVED 275
BALLISTIC RETICLE

#7279 3x-10x44 ZOOM
ENGRAVED 275 BALLISTIC
RETICLE WITH ILLUMINATED DOT

FEATURES

- › ENGRAVED 275 RETICLE (#7278)
- › ENGRAVED 275 RETICLE WITH ILLUMINATED DOT IN RED AND BLUE (#7279)
- › FINGER ADJUSTABLE TURRETS
- › NITROGEN PURGED, 100%
- › WATERPROOF, SHOCKPROOF, FOGPROOF
- › MULTI-COATED OPTICS
- › PRECISION 1/4 M.O.A. ADJUSTMENTS

CODE	7278	7279
MAGNIFICATION X OBJECTIVE DIAMETER	3-9X40 ZOOM	3-10X44 ZOOM
RETICLE	275 BALLISTIC	275 BALLISTIC W/ILLUMIN. DOT
FIELD OF VIEW (AT 100M/YDS)	11.5M - 38FT AT 3X 3.8M - 12.5 FT AT 9X	10.7M - 35FT AT 3X 3.3M - 10.8 FT AT 10X
WEIGHT (GR/OZ)	399 GR - 14.1 OZ	498 GR - 17.6 OZ
LENGTH (MM/INCHES)	315 MM - 12.4"	335 MM - 13.2"
EYE RELIEF (MM/INCHES)	76 MM - 2.9"	76.2 MM - 3"
EXIT PUPIL (MM)	13.3 AT 3X 4.4 AT 9X	14.7 AT 3X 4.4 AT 10X
CLICK VALUE (AT 100M/YDS)	1/4 M.O.A	1/4 M.O.A
ADJUSTING RANGE (AT 100M/YDS)	1.3 M 51.1"	1.3 M 51.1"
MOUNTING LENGTH (MM/INCHES)	142 MM 5.6"	142 MM 5.6"

A SPECIAL BALLISTIC RETICLE FOR SHORT/MEDIUM DISTANCE SHOOTING

The Konuspro-275 models help to remove the guesswork out of shooting, since their reticle is featuring several aiming points that are calibrated from 75 to 275 yards and coincide with the most popular loads. Lateral hash marks have also been added to compensate for wind. These riflescopes consequentially provide an undeniable advantage in terms of improved accuracy and better performance.



#7256 3x-12x50 ZOOM
ENGRAVED
30/30 RETICLE

#7259 6x-24x44 ZOOM
ENGRAVED
MIL-DOT RETICLE

FEATURES

- › ADJUSTABLE OBJECTIVE
- › SUNSHADE INCLUDED (#7256)
- › FINGER ADJUSTABLE TURRETS
- › NITROGEN PURGED, 100%
- › WATERPROOF, SHOCKPROOF, FOGPROOF
- › MULTI-COATED OPTICS
- › 30/30 ENGRAVED RETICLE (#7256)
- › PRECISION 1/4 M.O.A. ADJUSTMENTS (#7256)
- › MIL-DOT ENGRAVED RETICLE (#7259)
- › PRECISION 1/8 M.O.A. ADJUSTMENTS (#7259)

CODE	7256	7259
MAGNIFICATION X OBJECTIVE DIAMETER	3-12X50 ZOOM	6-24X44 ZOOM
RETICLE	30/30	MIL-DOT
FIELD OF VIEW (AT 100M/YDS)	9.5M - 31FT AT 3X 2.4M - 7.8FT AT 12X	5.02M - 31FT AT 6X 1.24M - 4FT AT 24X
WEIGHT (GR/OZ)	697 GR - 24.6 OZ	598 GR - 21.1 OZ
LENGTH (MM/INCHES)	355 MM - 14"	406 MM - 16"
EYE RELIEF (MM/INCHES)	76.2 MM 3"	76 MM 2.9"
EXIT PUPIL (MM)	16.7 AT 3X 4.2 AT 12X	7.4 AT 6X 2 AT 24X
CLICK VALUE (AT 100M/YDS)	1/4 M.O.A.	1/8 M.O.A.
ADJUSTING RANGE (AT 100M/YDS)	1.74 M - 68.5"	1.06 M - 41.8"
MOUNTING LENGTH (MM/INCHES)	138 MM - 5.4"	165 MM - 6.5"

RIFLESCOPES WITH ADJUSTABLE OBJECTIVE

These models include the adjustable objective for the automatic correction of the parallax from 10 yard to infinity, while the #7256 also comes with sunshade.

They are suitable for most types of game and are competitively priced.



SECOND FOCAL PLANE



IDEAL FOR HUNTING



1" TUBE DIAMETER

KONUSPRO

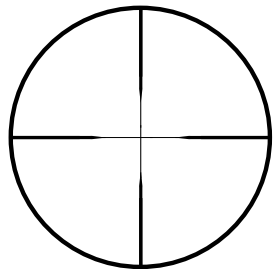

#7264 3x-9x40 ZOOM
ENGRAVED
30/30 RETICLE

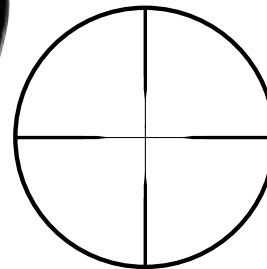

#7255 3x-10x44 ZOOM
ENGRAVED
30/30 RETICLE

FEATURES

- › FINGER ADJUSTABLE TURRETS
- › NITROGEN PURGED, 100%
- › WATERPROOF, SHOCKPROOF, FOGPROOF
- › MULTI-COATED OPTICS
- › 30/30 ENGRAVED RETICLE
- › PRECISION 1/4 M.O.A. ADJUSTMENTS

CODE	7264	7255
MAGNIFICATION X OBJECTIVE DIAMETER	3-9X40 ZOOM	3-10X44 ZOOM
RETICLE	30/30	30/30
FIELD OF VIEW (AT 100M/YDS)	11.5M - 38FT AT 3X 3.8M - 12.5FT AT 9X	10.7M - 35FT AT 3X 3.3M - 10.8FT AT 10X
WEIGHT (GR/OZ)	399 GR - 14.1 OZ	500 GR - 17.6 OZ
LENGTH (MM/INCHES)	325MM - 12.8"	340MM - 13.4"
EYE RELIEF (MM/INCHES)	76 MM - 2.9"	76.2 MM - 3"
EXIT PUPIL (MM)	13.3 AT 3X 4.4 AT 9X	14.7 AT 3X 4.4 AT 10X
CLICK VALUE (AT 100M/YDS)	1/4 M.O.A.	1/4 M.O.A.
ADJUSTING RANGE (AT 100M/YDS)	1.3 M - 52.4"	2.03 M - 80"
MOUNTING LENGTH (MM/INCHES)	142 MM - 5.6"	140 MM - 5.5"

THE ENGRAVED RETICLE TECHNOLOGY

These riflescopes are some of the best-selling units in the whole Konuspro range.

Supremely rugged and perfectly recoil-proof, they come with an engraved/laser etched reticle that will be able to withstand extreme forces and will not break, shift or snap even if the riflescope is used with heavy calibers.

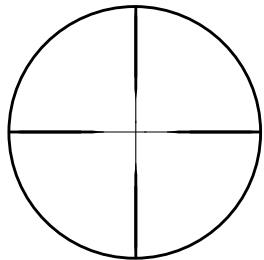

#7265 3x-9x50 ZOOM
ENGRAVED
30/30 RETICLE

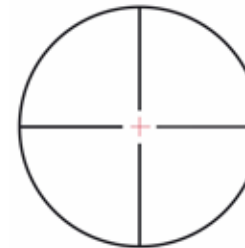

#7294 3x-9x50 ZOOM
ENGRAVED 30/30 RETICLE WITH DUAL
ILLUMINATION (RED-BLUE)

FEATURES

- › ENGRAVED 30/30 RETICLE WITH DUAL ILLUMINATION (RED-BLUE) (#7294)
- › ENGRAVED 30/30 RETICLE (#7265)
- › FINGER ADJUSTABLE TURRETS
- › NITROGEN PURGED, 100%
- › WATERPROOF, SHOCKPROOF, FOGPROOF
- › MULTI-COATED OPTICS
- › PRECISION 1/4 M.O.A. ADJUSTMENTS

CODE	7265	7294
MAGNIFICATION X OBJECTIVE DIAMETER	3-9X50 ZOOM	3-9X50 ZOOM
RETICLE	30/30	30/30 ILLUMINATED
FIELD OF VIEW (AT 100M/YDS)	11.5M - 38FT AT 3X 3.8M - 12.5FT AT 9X	11.5M - 38FT AT 3X 3.8M - 12.5FT AT 9X
WEIGHT (GR/OZ)	499 GR - 17.6 OZ	510 GR - 18 OZ
LENGTH (MM/INCHES)	355MM - 14"	348MM - 13.7"
EYE RELIEF (MM/INCHES)	76 MM 2.9"	76.2 MM 3"
EXIT PUPIL (MM)	16.7 AT 3X 5.5 AT 9X	16.7 AT 3X 5.5 AT 9X
CLICK VALUE (AT 100M/YDS)	1/4 M.O.A	1/4 M.O.A
ADJUSTING RANGE (AT 100M/YDS)	1.3 M - 52.4"	1.3 M - 52.4"
MOUNTING LENGTH (MM/INCHES)	151 MM - 5.9"	150 MM - 5.9"

THE ENGRAVED RETICLE TECHNOLOGY

These riflescopes are some of the best-selling units in the whole Konuspro range. Supremely rugged and perfectly recoil-proof, they come with an engraved/laser etched reticle that will be able to withstand extreme forces and will not break, shift or snap even if the riflescope is used with heavy calibers.



SECOND FOCAL PLANE



IDEAL FOR HUNTING



1" TUBE DIAMETER

KONUSPRO

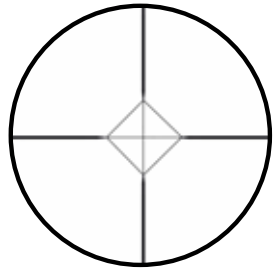

#7249 1.5x-5x32 ZOOM
ENGRAVED
AIM-PRO RETICLE

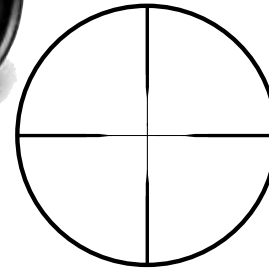

#7267 3x-9x32 A.O. ZOOM
ENGRAVED
30/30 RETICLE

FEATURES

- › FINGER ADJUSTABLE TURRETS
- › NITROGEN PURGED, 100%
- › WATERPROOF, SHOCKPROOF, FOGPROOF
- › MULTI-COATED OPTICS
- › WITH MOUNTING RINGS (#7267)
- › ADJUSTABLE OBJECTIVE (#7267)
- › PRECISION 1/4 M.O.A. ADJUSTMENTS

CODE	7249	7267
MAGNIFICATION X OBJECTIVE DIAMETER	1.5-5X32 ZOOM	3-9X32 A.O.
RETICLE	AIM-PRO	30/30
FIELD OF VIEW (AT 100M/YDS)	18.4M - 60FT AT 1.5X 6M - 20 FT AT 5X	9.9M - 32.4FT AT 3X 3.8M - 12.4FT AT 9X
WEIGHT (GR/OZ)	419 GR - 14.1 OZ	503 GR - 17.7 OZ
LENGTH (MM/INCHES)	284MM - 11.6"	325MM - 12.8"
EYE RELIEF (MM/INCHES)	76 MM - 2.9"	76 MM - 2.9"
EXIT PUPIL (MM)	21.3 AT 1.5X 6.4 AT 5X	10.6 AT 3X 3.5 AT 9X
CLICK VALUE (AT 100M/YDS)	1/4 M.O.A.	1/4 M.O.A.
ADJUSTING RANGE (AT 100M/YDS)	2.12 M - 83.7"	2 M - 78.7"
MOUNTING LENGTH (MM/INCHES)	126 M - 4.9"	128 MM - 5.03"

THE ENGRAVED RETICLE TECHNOLOGY FOR SHOTGUNS AND AIRGUNS

The Konuspro riflescopes feature a reticle that is actually etched onto precision, multi-coated optical glass, thus eliminating the chance of breaking or misalignment.

The #7249 is especially suitable for shooting at close range, while the #7267 comes with an adjustable objective and mounting rings and is therefore ideal for intermediate airguns models.

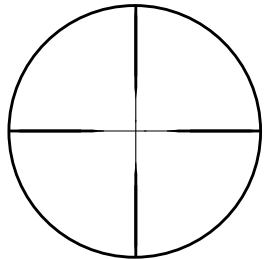

#7260 2x-7x32 ZOOM
ENGRAVED
30/30 RETICLE

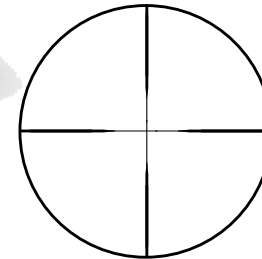

#7262 4x32
ENGRAVED
30/30 RETICLE

FEATURES

- › WITH MOUNTING RINGS
- › FINGER ADJUSTABLE TURRETS
- › NITROGEN PURGED 100% WATERPROOF
- › MULTI-COATED OPTICS
- › WATERPROOF, SHOCKPROOF, FOGPROOF
- › PRECISION 1/4 M.O.A. ADJUSTMENTS (#7262)
- › PRECISION 1/2 M.O.A. ADJUSTMENTS (#7260)

CODE	7260	7262
MAGNIFICATION X OBJECTIVE DIAMETER	2-7X32 ZOOM	4X32
RETICLE	30/30	30/30
FIELD OF VIEW (AT 100M/YDS)	14.3M - 43FT AT 2X 4.2M - 12.6FT AT 7X	8.8 M - 29 FT
WEIGHT (GR/OZ)	399 GR - 14.1 OZ	360 GR - 12.6 OZ
LENGTH (MM/INCHES)	305MM - 12"	244MM - 9.6"
EYE RELIEF (MM/INCHES)	76 MM 2.9"	114 MM 4.5"
EXIT PUPIL (MM)	8 AT 2X 4 AT 7X	8
CLICK VALUE (AT 100M/YDS)	1/2 M.O.A.	1/4 M.O.A.
ADJUSTING RANGE (AT 100M/YDS)	1.6 M - 69"	1.6 M - 69"
MOUNTING LENGTH (MM/INCHES)	125 MM - 4.9"	103 MM - 4.07"

RIFLESCOPES WITH ENGRAVED RETICLE AND MOUNTING RINGS

These riflescopes with low magnification power are ideal for .22 caliber rifles and are undoubtedly the best choice for shooting at short-medium range or for shooting at fast moving targets.



SECOND FOCAL PLANE



IDEAL FOR HUNTING



1" TUBE DIAMETER

KONUSFIRE • KONUSHOT

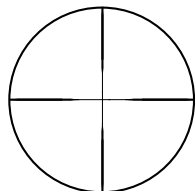

#7350 4x32 KONUSFIRE
30/30 RETICLE

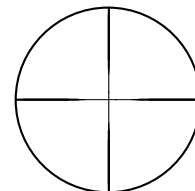

#7235 3x-12x40 ZOOM
KONUSHOT
30/30 RETICLE

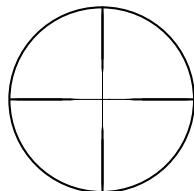

#7351 3x-9x32 ZOOM
KONUSFIRE
30/30 RETICLE

FEATURES

- › METAL CONSTRUCTION (#7235)
- › 30/30 RETICLE
- › COATED OPTICS
- › 1/4 M.O.A. ADJUSTABLE TURRETS
- › WITH .22 DOVETAIL MOUNTING RINGS INCLUDED (#7350 AND #7351)

CODE	7350	7351	7235
MAGNIFICATION X OBJECTIVE DIAMETER	4X32	3-9X32 ZOOM	3-12X40 ZOOM
RETICLE	30/30	30/30	30/30
FIELD OF VIEW (AT 100M/YDS)	9.1 M 23.7 FT	11.2M - 36.7FT AT 3X 3.7M - 12.1FT AT 9X	9.5M - 27.4 FT AT 3X 2.4M - 6.9 FT AT 12X
WEIGHT (GR/OZ)	320 GR - 11.2 OZ	360 GR - 12.6 OZ	391 GR - 13.7 OZ
LENGTH (MM/INCHES)	253MM - 9.96"	305MM - 12"	335MM - 13.1"
EYE RELIEF (MM/INCHES)	76 MM 2.9"	76 MM 2.9"	76 MM 2.9"
EXIT PUPIL (MM)	8	10.6 AT 3X 3.5 AT 9X	13.3 AT 3X 3.3 AT 12X
CLICK VALUE (AT 100M/YDS)	1/4 M.O.A	1/4 M.O.A.	1/4 M.O.A
ADJUSTING RANGE (AT 100M/YDS)	1.75 M 70"	2 M 78.7"	1.59M 62"
MOUNTING LENGTH	115 MM - 4.52"	128 MM - 5.03"	465 MM - 18.3"

PRACTICAL AND AFFORDABLE RIFLESCOPES

The Konushot and Konusfire riflescopes are designed as a great choice for shooters who are looking for an inexpensive yet dependable instrument, as well as they are supremely suited as "first scopes" for every beginner sportsman.

STEEL RINGS



#7400 Ø1" - 25.4MM
#7403 Ø30MM

PAIR OF STEEL MOUNTING RINGS FOR RIFLESCOPES

- › HIGH PROFILE
- › DURABLE STEEL CONSTRUCTION
- › HEAVY DUTY TORX SCREWS
- › SQUARE RECOIL LUG

#7401 Ø1" - 25.4MM
#7404 Ø30MM

PAIR OF STEEL MOUNTING RINGS FOR RIFLESCOPES

- › MEDIUM PROFILE
- › DURABLE STEEL CONSTRUCTION
- › HEAVY DUTY TORX SCREWS
- › SQUARE RECOIL LUG

#7402 Ø1" - 25.4MM
#7405 Ø30MM

PAIR OF STEEL MOUNTING RINGS FOR RIFLESCOPES

- › LOW PROFILE
- › DURABLE STEEL CONSTRUCTION
- › HEAVY DUTY TORX SCREWS
- › SQUARE RECOIL LUG

CODE	7400	7401	7402	7403	7404	7405
DIAMETER	25,4 MM (1")	25,4 MM (1")	25,4 MM (1")	30 MM	30 MM	30 MM
PROFILE (SADDLE HEIGHT)	HIGH (27.1 MM)	MEDIUM (21.3 MM)	LOW (17.1 MM)	HIGH (29.4 MM)	MEDIUM (23.6 MM)	LOW (19.4 MM)
NUMBER OF SCREWS	4	4	4	4	4	4
WEIGHT GR/OZ	175.7 GR 6.2 OZ	146.8 GR 5.18 OZ	124.7 GR 4.4 OZ	181.7 GR 6.41 OZ	152.8 GR 5.39 OZ	139.7 GR 4.93 OZ
RECOMMENDED RIFLESCOPE Ø	UP TO 52 MM	UP TO 40 MM	UP TO 32 MM	UP TO 56 MM	UP TO 44 MM	UP TO 32 MM

FOR PICATINNY AND WEAVER RAILS

A complete assortment of high quality steel mounting rings for riflescopes. Suitable for Weaver/Picatinny rails, they are available in both 30mm or 1" diameter.

STEEL RINGS



#7406 Ø1" - 25.4MM

#7409 Ø30MM

QUICK RELEASE STEEL MOUNTING RINGS FOR RIFLESCOPES

- › HIGH PROFILE
- › DURABLE STEEL CONSTRUCTION
- › HEAVY DUTY TORX SCREWS
- › SQUARE RECOIL LUG
- › QUICK RELEASE LEVER SYSTEM

#7407 Ø1" - 25.4MM

#7410 Ø30MM

QUICK RELEASE STEEL MOUNTING RINGS FOR RIFLESCOPES

- › MEDIUM PROFILE
- › DURABLE STEEL CONSTRUCTION
- › HEAVY DUTY TORX SCREWS
- › SQUARE RECOIL LUG
- › QUICK RELEASE LEVER SYSTEM

#7408 Ø1" - 25.4MM

#7411 Ø30MM

QUICK RELEASE STEEL MOUNTING RINGS FOR RIFLESCOPES

- › LOW PROFILE
- › DURABLE STEEL CONSTRUCTION
- › HEAVY DUTY TORX SCREWS
- › SQUARE RECOIL LUG
- › QUICK RELEASE LEVER SYSTEM

CODE	7406	7407	7408	7409	7410	7411
DIAMETER	25,4 MM (1")	25,4 MM (1")	25,4 MM (1")	30 MM	30 MM	30 MM
PROFILE (SADDLE HEIGHT)	HIGH (27.0 MM)	MEDIUM (21.2 MM)	LOW (17.0 MM)	HIGH (30 MM)	MEDIUM (23.5 MM)	LOW (19.3 MM)
NUMBER OF SCREWS	4	4	4	4	4	4
WEIGHT GR/OZ	189.9 GR 6.7 OZ	157.9 GR 5.57 OZ	135.7 GR 4.79 OZ	204 GR 7.19 OZ	174.9 GR 6.17 OZ	162.7 GR 5.74 OZ
RECOMMENDED RIFLESCOPE Ø	UP TO 52 MM	UP TO 40 MM	UP TO 32 MM	UP TO 56 MM	UP TO 44 MM	UP TO 32 MM

FOR PICATINNY AND WEAVER RAILS WITH QUICK RELEASE FUNCTION

A complete assortment of high quality steel mounting rings for riflescopes. With a special quick release system. Suitable for Weaver/Picatinny rails, they are available in both 30mm or 1" diameter.

STEEL RINGS



#7415 Ø1" - 25.4MM
#7418 Ø30MM

- STEEL MOUNTING RINGS FOR RIFLESCOPES
- › HIGH PROFILE
 - › DURABLE STEEL CONSTRUCTION
 - › HEAVY DUTY TORX SCREWS
 - › SQUARE RECOIL LUG

#7416 Ø1" - 25.4MM
#7419 Ø30MM

- STEEL MOUNTING RINGS FOR RIFLESCOPES
- › MEDIUM PROFILE
 - › DURABLE STEEL CONSTRUCTION
 - › HEAVY DUTY TORX SCREWS
 - › SQUARE RECOIL LUG

#7417 Ø1" - 25.4MM
#7420 Ø30MM

- STEEL MOUNTING RINGS FOR RIFLESCOPES
- › LOW PROFILE
 - › DURABLE STEEL CONSTRUCTION
 - › HEAVY DUTY TORX SCREWS
 - › SQUARE RECOIL LUG

CODE	7415	7416	7417	7418	7419	7420
DIAMETER	25,4 MM (1")	25,4 MM (1")	25,4 MM (1")	30 MM	30 MM	30 MM
PROFILE (SADDLE HEIGHT)	HIGH (25.45MM)	MEDIUM (22.05MM)	LOW (19.45MM)	HIGH (27.75MM)	MEDIUM (24.75MM)	LOW (21.75MM)
NUMBER OF SCREWS	4	4	4	4	4	4
WEIGHT GR/OZ	130 GR 4.58 OZ	101.1 GR 3.56 OZ	79 GR 2.78 OZ	162.9 GR 5.72 OZ	134 GR 4.72 OZ	120.9 GR 42.6 OZ
RECOMMENDED RIFLESCOPE Ø	UP TO 52 MM	UP TO 40 MM	UP TO 32 MM	UP TO 56 MM	UP TO 44 MM	UP TO 32 MM

FOR .22 RAILS AND AIRGUNS

A complete assortment of high quality steel mounting rings for riflescopes. Suitable for .22 rails and Airguns, they are available in both 30mm or 1" diameter.

CANTILEVER MOUNT



#7219



FEATURES

- › ADJUSTABLE LENGTH
- › ADJUSTABLE HEIGHT
- › SUITABLE FOR WEAVER/PICATINNY RAILS
- › INTEGRATED RAIL SYSTEM FOR ACCESSORIES
- › ADD OR REMOVE THE INTERNAL RINGS IN ORDER TO SWITCH FROM 1" TO 30MM DIAMETER
- › ALLEN KEY INCLUDED

THE MOST ADVANCED MOUNTING SYSTEM IN THE INDUSTRY

A truly universal mount that is fully adjustable in both length and height. It will fit any Weaver and Picatinny rail and it will also allow for the placement of additional accessories on its top. As an extra bonus, it can accommodate both 1" or 30mm riflescopes by adding or removing the internal rings it comes complete with.

MOUNTING ACCESSORIES



#7218
DUAL-T
PAIR OF MOUNTING RINGS



#7237
UNIVERSAL MODE
Ø25.4-30MM DUAL USE

FEATURES

#7218

- › ADD OR REMOVE THE INTERNAL RINGS IN ORDER TO SWITCH FROM 1" TO 30MM DIAMETER
- › LOCKING BASE SUITABLE FOR WEAVER AND PICATINNY RAIL
- › IDEAL FOR VERY COMPACT RIFLESCOPES

#7237

- › ADD OR REMOVE THE INTERNAL RINGS IN ORDER TO SWITCH FROM 1" TO 30MM DIAMETER
- › DUAL REVERSIBLE BASE FOR .22 CALIBER AND WEAVER/PICATINNY RAIL
- › ALL MODELS WITH RECOIL-STOP
- › INTERNAL ANTI-SCRATCH PADDING
- › STRONG ANODISED ALUMINUM

CODE	7218	7237
RING HEIGHT	22.1MM 0.87"	25.5MM 1"
SUITABLE FOR	30MM AND 1" RIFLESCOPES	30MM AND 1" RIFLESCOPES
TOTAL HEIGHT	52MM 2"	57MM 2.24"
LENGTH	45MM 1.7"	25.4MM 1"

UNIVERSAL MOUNTS FOR RIFLESCOPES

These mounting rings for Weaver and Picatinny rails are made from aircraft aluminum and are supremely versatile, because they are able to accommodate both the 30mm or 1" scopes by adding or removing the internal rings they come complete with.

The #7237 has a dual reversible base that will fit the .22 rail as well.



FISSION



#7205 FISSION 3
RED DOT WITH 8 INTENSITIES

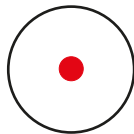

#7206 FISSION-MR
RED DOT WITH 10 INTENSITIES

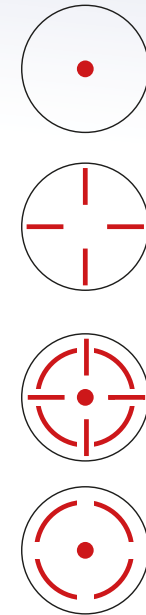

FEATURES

#7205

- › 1X RED DOT WITH 8 BRIGHTNESS SETTINGS
- › 4 M.O.A. DOT SIZE
- › WATERPROOF
- › SUITABLE FOR WEAVER/PICATINNY RAILS
- › INCLUDES DELTAPOINT PRO (SHIELD RMS/SMS) FOOTPRINT FOR DIRECT MOUNTING
- › 12-HOUR AUTO SHUT-OFF

#7206

- › 1X RED DOT WITH 10 BRIGHTNESS SETTINGS
- › 4 INTERCHANGEABLE RETICLES
- › WATERPROOF
- › INCLUDES DELTAPOINT PRO (SHIELD RMS/SMS) FOOTPRINT FOR DIRECT MOUNTING
- › 12-HOUR AUTO SHUT-OFF

CODE	7205	7206
MODEL	FISSION 3	FISSION-MR
DIAMETER	25X18 MM 0.98"X0.7"	25X18 MM 0.98"X0.7"
LENGTH MM/INCHES	45.7 MM 1.8"	49.7 MM 1.96"
WEIGHT GR/OZ	60 GR 2.11 OZ	65 GR 2.29 OZ
DOT SIZE	4 M.O.A	DOT SIZE: 4 M.O.A. CIRCLE SIZE: 40 M.O.A. CROSS SIZE: 50 M.O.A..

TECHNOLOGICALLY ADVANCED RED DOTS

Two models with a supremely versatile base that fits a Weaver/Picatinny rail and is also directly mountable to DeltaPoint Pro standard by virtue of its special footprint.

These highly advanced red dots are also waterproof and include a 12-hour auto shut-off function to prevent battery consumption.

The # 7205 is a single dot version, while the # 7206 features 4 interchangeable reticle options.

SIGHT PRO

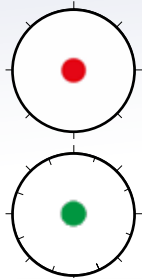

#7215 NUCLEAR-QR 1x22
RED/GREEN DOT WITH
5 INTENSITIES

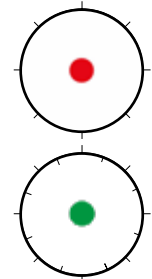

#7217 NUCLEAR 1x22
RED/GREEN DOT WITH
8 INTENSITIES

FEATURES

#7215

- › DUAL MOUNTING SYSTEM: HIGH (WITH QUICK RELEASE) AND LOW
- › EYE RELIEF: UNLIMITED
- › SHOCKPROOF/WATER RESISTANT
- › LOW MOUNT IS SUITABLE FOR WEAVER/PICATINNY RAILS
- › HIGH MOUNT IS SUITABLE FOR PICATINNY RAILS

#7217

- › DUAL MOUNTING SYSTEM: HIGH AND LOW
- › EYE RELIEF: UNLIMITED
- › SHOCKPROOF/NITROGEN FILLED/WATERPROOF/ FOGPROOF
- › SUITABLE FOR WEAVER/PICATINNY RAILS

CODE	7215	7217
MODEL	NUCLEAR-QR	NUCLEAR
DIAMETER	22MM 0.86"	22MM 0.86"
LENGTH MM/INCHES	70MM 2.75"	70MM 2.75"
WEIGHT GR/OZ	140 GR 4.9OZ	140 GR 4.9OZ
DOT SIZE	3 M.O.A.	3 M.O.A.

TECHNOLOGICALLY ADVANCED RED DOTS

Our comprehensive assortment of Red Dots features many invaluable options for the highly demanding tactical field. Among these models, the # 7215 (with Quick-Release) and the # 7217 are uniquely versatile because they come with a dual mounting system and with a special riser that allows for a much higher placement if needed.



RED/GREEN DOT SIGHT WITH 8 INTERCHANGEABLE RETICLES



#7378 1x35

RED/GREEN DOT SIGHT WITH 4 INTERCHANGEABLE RETICLES

FEATURES

#7376

- › 8 INTERCHANGEABLE RETICLES
- › ILLUMINATION IN RED OR GREEN
- › M.O.A. DOT SIZE FROM 2 TO 5 ACCORDING TO THE RETICLE
- › DUAL MOUNT SUITABLE FOR 7/8" AND 3/8" RAIL
- › WORKS WITH RECHARGEABLE BATTERY AND/OR CR2032 BATTERY

#7278

- › 4 INTERCHANGEABLE RETICLES
- › ILLUMINATION IN RED OR GREEN
- › DUAL MOUNT, SUITABLE FOR 7/8" AND 3/8" RAIL
- › TACTICAL TURRETS
- › INTEGRATED RAIL SYSTEM
- › WATER RESISTANT

CODE	7376	7378
MODEL	SIGHT PRO R8	KONUSIGHT
DIAMETER	39X27 MM 1.5"X1.06"	35MM
LENGTH MM/INCHES	108 MM 4.3"	105 MM 4.13"
WEIGHT GR/OZ	245 GR 8.6 OZ	348 GR 12.2 OZ
DOT SIZE	2 M.O.A. 5 M.O.A.	4 M.O.A.

TECHNOLOGICALLY ADVANCED RED DOTS

Ideal for both standard weapons and assault rifles, these Red Dots are among the most professional units of their entire category.

Both models come with an array of reticles that will accommodate the needs of every shooter out there.

They also include an additional mounting piece for switching from 7/8" rails to 3/8" rails.

PTS2

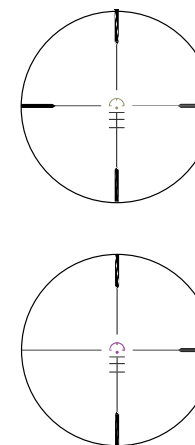

#7203 PTS2 3x30
RED/BLUE
ILLUMINATION

FEATURES

- › 3X POWER MAGNIFICATION
- › FULLY MULTI-COATED LENSES
- › 1/3 M.O.A. ADJUSTMENT TURRETS
- › INTEGRATED TRI-RAIL SYSTEM
- › RED/BLUE ILLUMINATION
- › MOUNT SUITABLE FOR WEAVER/PICATINNY RAILS
- › NITROGEN PURGED, WATERPROOF, FOGPROOF, SHOCKPROOF
- › FLIP-UP LENS COVERS

CODICE	7203
MODELLO	SIGHT PRO PTS2
DIAMETRO	30MM
LUNGHEZZA	146 MM 5.74"
PESO	480 GR 16.9 OZ
MISURA DEL PUNTO	2.8 M.O.A.

HIGHLY ADVANCED PRISMATIC SCOPE

The # 7203 is a supremely rugged and reliable unit that is tailor-made for the tactical industry: for additional versatility, it also features an integrated tri-rail system that will allow for the placement of flashlights or other accessories.



#3940 KONUSLIGHT-TL

FEATURES

- › WATERPROOF
- › LED TYPE: CREE-XPG-2
- › POWER OUTPUT 360 LUMENS - 3W
- › BATTERY TYPE CR2 LITHIUM (INCLUDED)
- › LENGTH 2.47" - 62.7MM
- › BEZEL DIAMETER 1.55" - 39.3MM
- › BODY WIDTH 1.57" - 39.8MM
- › QUICK RELEASE MOUNT
- › SUITABLE FOR WEAVER/PICATINNY RAIL
- › FLASHING FUNCTION

PROFESSIONAL TACTICAL FLASHLIGHT

The Konuslight-TL is a supremely compact and lightweight tactical flashlight with a quick release mount that will fit any Weaver/Picatinny rail.



THERMAL SYSTEMS

Taking its acclaimed line of thermal optics to the next level, Konus is proud to introduce two brand new models with state-of-the-art features for every hunting and tactical scenario. The # 7964 combines a supremely advanced thermal technology with the body of a traditional riflescope. The # 7960 is a revolutionary 3-in-1 concept that can work at the same time as monocular, riflescope or clip-on, while including all of the necessary accessories for the 3 configurations.



FIERY-R



#7964 3.4X-13.6X50 ZOOM

6 SELECTABLE PALETTES

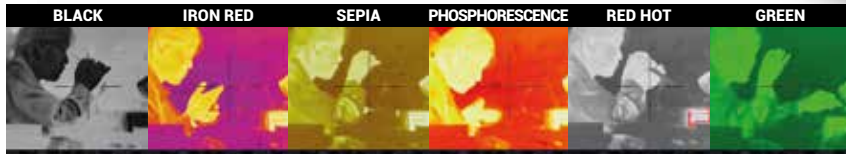

THERMAL MODULE		SMART FUNCTION	
IMAGE SENSOR	384x288 pixels	WI-FI HOT SPOT	YES
MAX RESOLUTION	1024x768 pixels	STAND-BY MODE	YES
RESPONSE WAVEBAND	12µm	SYSTEM	
NETD	≤40mK@f/1.0	STORAGE	BUILT-IN MEMORY 32GB
LENS (FOCAL LENGTH)	50mm	RECORD VIDEO	YES
FIELD OF VIEW	H: 5.27°; V: 3.96°	CAPTURE SNAPSHOT	YES
DIGITAL ZOOM	1X - 4X	POWER SUPPLY	
MAGNIFICATION	3.4x-13.6x	BATTERY TYPE	Built-in 2 pcs 6400mAh
IMAGE DISPLAY		BATTERY OPERATING TIME	≥14h
MONITOR	OLED 1024x768	BATTERY CAPACITY DISPLAY	YES
PALETTES	Black hot, Iron Red, Sepia, Fosforescence, Red hot, Green hot	GENERAL	
FRAME FREQUENCY	50Hz	POWER	5 VDC/1 A
		WORKING TEMPERATURE	-20 °C to +50 °C (-4 °F to +122 °F)
		PROTECTION LEVEL	SUMERSIBLE WATERPROOF IP-67
		DIMENSIONS	375 mm × 89 mm × 77 mm (14.7" × 3.5" × 3.03")

10 INTERCHANGEABLE RETICLES

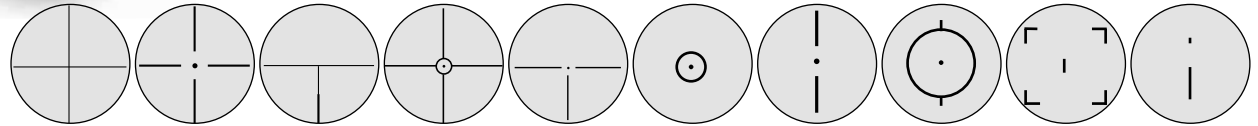

FEATURES

- › 384X288 RESOLUTION WITH 50MM FOCAL LENGTH
- › 10 SELECTABLE RETICLES IN 8 COLORS
- › 6 PALETTES
- › DUAL RECHARGEABLE BATTERY SYSTEM (ONE BUILT-IN BATTERY AND ONE REMOVABLE BATTERY)
- › PHOTO AND VIDEO RECORDING FUNCTION
- › AUTOMATIC RECORDING OF EVERY SHOT
- › 32GB MEMORY MODULE
- › WI-FI HOTSPOT
- › AUTO SHUT-OFF
- › WATERPROOF, FOGPROOF, SHOCKPROOF
- › RECOIL RESISTANCE: 6000 JOULES

CODE	#7264
MAGNIFICATION X OBJECTIVE DIAMETER	3.4-13.6X50
RETICLE	10 DIFFERENT RETICLES
FIELD OF VIEW HXW (M - F)	9.2X6.9M 30.18X22.63 FT
WEIGHT (GR - OZ)	890 GR 31.39 OZ
LENGTH (MM - INCHES)	375 MM - 14.7"
EYE RELIEF (MM - INCHES)	59.9MM - 2.36"
EXIT PUPIL MM	8
DETECTION RANGE (M - YDS)	2500 M 2734YDS

THE THERMAL SUPREMACY

While having the appearance, dimensions and ease-of-use of a traditional riflescope with 3.4x-13.6x zoom magnification and 50mm objective diameter, the # 7964 is powered up by the most professional thermal technology and is chock-full of other incomparable features like 10 interchangeable reticles in 8 different colors, 6 selectable palettes, photo and video taking function, automatic recording of every shot and so forth. And on top of everything else it is virtually indestructible, having a recoil resistance of 6000 joules when a .308 rifle will typically generate no more than 3500 joules.

FIERY-RF



#7960 FIERY-RF

4 SELECTABLE PALETTES



THERMAL MODULE		SMART FUNCTION	
IMAGE SENSOR	384x288 pixels	WI-FI HOT SPOT	YES
MAX RESOLUTION	1024x758 pixels	STAND-BY MODE	YES
RESPONSE WAVEBAND	8μm ~14μm	SYSTEM	
NETD	≤35mK@f/1.0	STORAGE	32GB
LENS (FOCAL LENGTH)	35mm	RECORD VIDEO	YES
FIELD OF VIEW	H: 7.5°; V: 5.7°	CAPTURE SNAPSHOT	YES
DIGITAL ZOOM	1x; 2x; 4x; 8x	POWER SUPPLY	
APERTURE	F1.0	BATTERY TYPE	Built-in 18650
MAGNIFICATION	3X - 24X	BATTERY OPERATING TIME	up to 4 hours (with hot spot function)
IMAGE DISPLAY		BATTERY CAPACITY DISPLAY	yes
MONITOR	0.39 inch OLED 1024x768	GENERAL	
FFC (FLAT FIELD CORRECTION)	Auto, manual, external correction	POWER	5 VDC 0.5 A
PALETTES	white hot - black hot red hot - iron red	WORKING TEMPERATURE	-20 °C to +55 °C (-4 °F to +131 °F)
FRAME FREQUENCY	50Hz	PROTECTION LEVEL	SUMERSIBLE WATERPROOF IP-67
		DIMENSIONS	215 mm × 75 mm × 68.5mm (8.4" × 2.9" × 2.69") (L × W × H)
		WEIGHT	520 g (18.34 oz)

6 INTERCHANGEABLE RETICLES

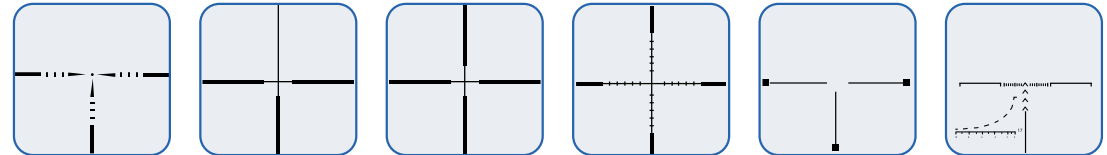

FEATURES

- › 3-IN-1 THERMAL MONOCULAR, RIFLESCOPE AND CLIP-ON
- › 384X288 RESOLUTION
- › 35MM FOCAL LENGTH
- › BUILT-IN RANGEFINDER (800 M - 880 YDS)
- › PHOTO AND VIDEO RECORDING FUNCTION
- › WI-FI HOT SPOT
- › BUILT-IN 32GB MEMORY MODULE
- › WORKS WITH RECHARGEABLE 18650 LITHIUM BATTERY
- › MONOCULAR AND RIFLESCOPE CONFIGURATIONS HAVE A 3X-24X ZOOM MAGNIFICATION POWER
- › RIFLESCOPE CONFIGURATION INCLUDES A MOUNTING SYSTEM FOR PICATINNY RAILS AND 6 RETICLES
- › CLIP-ON CONFIGURATION FITS EVERY RIFLESCOPE WITH 44MM-50MM-56MM OBJECTIVE DIAMETER VIA THE INCLUDED SET OF ADAPTERS



1. THERMAL MONOCULAR

2. RIFLESCOPE

3. CLIP-ON

THE 3-IN-1 THERMAL REVOLUTION

This exclusivity of Konus is a never-before-seen solution of unparalleled versatility in the thermal industry. It works at the same time as hand-held monocular, rifle scope or clip-on and it comes complete with all of the necessary accessories for the 3 configurations. As a monocular, it has a 3x-24x zoom magnification power and plenty of other exciting functions. As a rifle scope, it features 6 interchangeable reticles and a mounting system for Picatinny rails. As a clip-on, it will instantly fit every rifle scope with 44mm, 50mm or 56mm objective diameter by virtue of the included set of adapters. And each configuration can also take advantage of a built-in rangefinder with a maximum distance of 800 meters or 880 yards.



FLAME-R



5 SELECTABLE RETICLES IN 3 DIFFERENT COLORS (GREEN, WHITE, RED)

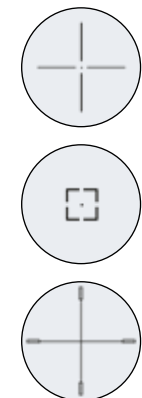

#7952 2.5X-20X ZOOM

4 SELECTABLE PALETTES



THERMAL MODULE		SMART FUNCTION	
IMAGE SENSOR	Vanadium Oxide Uncooled Focal Plane Arrays	HIGHEST TEMPERATURE SPOT TRACKING	YES
MAX RESOLUTION	256x192 pixels	WI-FI HOT SPOT	YES
RESPONSE WAVEBAND	8µm a 12µm	STAND-BY MODE	YES
NETD	less than 35mk (@25°C, F#=1.0)	SYSTEM	
LENS (FOCAL LENGTH)	19mm	STORAGE	Built-in Memory Module (16GB)
MRAD	1.13 mrad	RECORD VIDEO	YES
FIELD OF VIEW	9.24°x6.94° (HxV)	CAPTURE SNAPSHOT	YES
DIGITAL ZOOM	1x - 2x - 4x - 8x	POWER SUPPLY	
APERTURE	F1.0	BATTERY TYPE	Two CR123A (3V) Lithium - or two RCR123 (up to 4.2V)
MAGNIFICATION	2.47x	BATTERY OPERATING TIME	Up to five hours continuously running (with Wi-Fi hot spot function off)
IMAGE DISPLAY		BATTERY CAPACITY DISPLAY	YES
MONITOR	0.39 inch - OLED - 1024x768	GENERAL	
FFC (FLAT FIELD CORRECTION)	AUTO, MANUAL, EXTERNAL CORRECTION	POWER	5V DC/2A, 2W
PALETTES	BLACK HOT, WHITE HOT, RED HOT, FUSION	WORKING TEMPERATURE	from -20°C to 55°C (-4°F to 131°F)
FRAME FREQUENCY	50Hz	PROTECTION LEVEL	SUMERSIBLE WATERPROOF RATING IP-67
		DIMENSIONS	187.2mmx62.5mmx59.2mm (7.4"x2.5"x2.3")
		WEIGHT	430g (15.16 oz)

FEATURES

- › ALSO WORKS AS HAND-HELD THERMAL MONOCULAR
- › FEATURES 5 SELECTABLE RETICLE TYPES
- › WATERPROOF UP TO 3.3FT DEPTH
- › ZOOM MAGNIFICATION 2.5X-20X
- › 256X192 RESOLUTION
- › 4 DIFFERENT PALETTES
- › WORKS WITH TWO CR123 LITHIUM BATTERIES 3V (INCLUDED)
- › WI-FI HOT SPOT
- › VIDEO RECORDING FUNCTION
- › INCLUDES A MOUNTING SYSTEM FOR PICATINNY RAILS

DETECTION RANGE (STANDARD CAR SIZE)	2428 M 7.965.8 FT
DETECTION RANGE (AVERAGE HUMAN SIZE)	792 M 2.598 FT
RECOGNITION RANGE (STANDARD CAR SIZE)	607 M 1.991 FT
RECOGNITION RANGE (AVERAGE HUMAN SIZE)	198 M 649 FT
IDENTIFICATION RANGE (STANDARD CAR SIZE)	303 M 904 FT
IDENTIFICATION RANGE (AVERAGE HUMAN SIZE)	99 M 325 FT
WEIGHT (GR/OZ)	430 G 15.16 OZ
LENGTH	187.2 MM 7.3"

THE THERMAL DOMINATION

Power and technology come together to provide you with a supremely versatile unit that can be used as thermal rifle scope or hand-held monocular for countless hunting, tactical or surveillance purposes.

Fully waterproof, our #7952 model features a huge 2.5x-20x zoom magnification range to go along with 5 selectable digital reticles in 3 colors and with a special mount for Picatinny rails. Its thermal vision is available in 4 different palettes with 256x192 resolution and you can also take pictures or record videos of what you observe.

FIERY 2X-16X



#7957 2X-16X ZOOM

4 SELECTABLE PALETTES



THERMAL MODULE		SMART FUNCTION	
IMAGE SENSOR	400x300 pixels	HIGHEST TEMPERATURE SPOT TRACKING	YES
MAX RESOLUTION	1280x960 pixels	WI-FI HOT SPOT	YES
RESPONSE WAVEBAND	8µm a 14µm	MODALITÁ STAND-BY	YES
NETD	≤35 mK@f/1.0	SYSTEM	
LENS (FOCAL LENGTH)	19 mm	STORAGE	BUILT IN MEMORY MODULE (16GB)
MRAD	0.89mrad	RECORD VIDEO	YES
FIELD OF VIEW	H: 20.4°; V: 15.3°	CAPTURE SNAPSHOT	YES
DIGITAL ZOOM	1x; 2x; 4x; 8x	POWER SUPPLY	
APERTURE	F1.0	BATTERY TYPE	Built-in 18650
MAGNIFICATION	2x-16x	BATTERY OPERATING TIME	p to five hours continuously running (with Wi-Fi hot spot function off)
IMAGE DISPLAY		BATTERY CAPACITY DISPLAY	YES
MONITOR	0.4 inch LCOS 1280x960	GENERAL	
FFC (FLAT FIELD CORRECTION)	AUTO, MANUAL EXTERNAL CORRECTION	POWER	5 VDC, 0.5 A
PALETTES	BLACK HOT, WHITE HOT, RED HOT, FUSION	WORKING TEMPERATURE	-20 °C to +55 °C (-4 °F to +131 °F)
FRAME FREQUENCY	50Hz	PROTECTION LEVEL	SUMERSIBLE WATERPROOF RATING IP-67
		DIMENSIONS	187.5 mm × 66.5 mm × 68.5 mm (7.38" × 2.61" × 2.69") (L × W × H)
		WEIGHT	450 g (15.8 oz)

FEATURES

- › HANDHELD THERMAL MONOCULAR
- › 400X300 RESOLUTION WITH HIGH SENSITIVITY DETECTOR
- › 19MM FOCAL LENGTH
- › ZOOM MAGNIFICATION: 2X-16X
- › BUILT-IN RECHARGEABLE LITHIUM BATTERY
- › WI-FI HOT SPOT
- › MEMORY MODULE WITH 32GB SD CARD
- › 4 PALETTES: WHITE HOT/BLACK HOT/IRON RED/ALARM
- › DISTANCE CALCULATION VIA VIDEO ANALYSIS
- › RED DOT POINTER FOR QUICK TARGET ACQUISITION
- › PHOTO AND VIDEO RECORDING FUNCTION
- › FIRE WARNING FUNCTION WITH ALARM

DETECTION RANGE (STANDARD CAR SIZE)	1490 M 4888.4 FT
DETECTION RANGE (AVERAGE HUMAN SIZE)	650 M 2132.5 FT
RECOGNITION RANGE (STANDARD CAR SIZE)	370 M 1213.91 FT
RECOGNITION RANGE (AVERAGE HUMAN SIZE)	160 M 524.9 FT
IDENTIFICATION RANGE (STANDARD CAR SIZE)	190 M 623.3 FT
IDENTIFICATION RANGE (AVERAGE HUMAN SIZE)	80 M 262.4 FT
WEIGHT (GR/OZ)	450G 15.8 OZ
LENGTH	187.2MM 7.37"

THE THERMAL CONQUEST

Thermal imaging technology that performs at an unprecedented level by virtue of its 400x300 resolution (as opposed to the standard 384x288 resolution of most competing models) and its 2x-16x zoom power (as opposed to the much smaller magnification range of most competing models). On top of this, the # 7957 comes with plenty of unique features that further set it apart: 4 different palettes, Wi-Fi hotspot, photo/video recording function, distance calculation, fire warning alarm and so forth. It also includes a red dot pointer for easy and quick acquisition of what you want to observe.



FIERY 3X - 24X



#7959 3X - 24X ZOOM

6 SELECTABLE PALETTES



THERMAL MODULE		SMART FUNCTION	
IMAGE SENSOR	640x512 pixels	HIGHEST TEMPERATURE SPOT TRACKING	YES
MAX RESOLUTION	1440x1080 pixels	WI-FI HOT SPOT	YES
RESPONSE WAVEBAND	8µm ~14µm	STAND-BY MODE	YES
NETD		SYSTEM	
LENS (FOCAL LENGTH)	35mm	STORAGE	BUILT-IN MEMORY 32GB
MRAD	0.34mrad	RECORD VIDEO	YES
FIELD OF VIEW	H: 12.4°; V: 10.0°	CAPTURE SNAPSHOT	YES
DIGITAL ZOOM	1X 2X 4X 8X	POWER SUPPLY	
APERTURE	F1.0	BATTERY TYPE	Replaceable 18650
MAGNIFICATION	3x-24x	BATTERY OPERATING TIME	≥6.5h
IMAGE DISPLAY		BATTERY CAPACITY DISPLAY	YES
MONITOR	0.41 inch OLED 1440x1080	GENERAL	
FFC (FLAT FIELD CORRECTION)	AUTO, MANUAL EXTERNAL CORRECTION	POWER	5 VDC/1 A
PALETTES	White hot - sephia - green hot red hot - fusion - black hot	WORKING TEMPERATURE	-30 °C to +50 °C (-22 °F to +122 °F)
FRAME FREQUENCY	50Hz	PROTECTION LEVEL	SUMERSIBLE WATERPROOF IP-67
		DIMENSIONS	151.7 mm × 42.0 mm × 74.4 mm (5.98" × 1.65" × 2.93")
		WEIGHT	318G - 11.21 OZ

FEATURES

- › HANDHELD THERMAL MONOCULAR
- › 1440X1080 RESOLUTION WITH HIGH SENSITIVITY DETECTOR
- › 19MM FOCAL LENGTH
- › ZOOM MAGNIFICATION: 3X-24X
- › BUILT-IN RECHARGEABLE LITHIUM BATTERY
- › WI-FI HOT SPOT
- › MEMORY MODULE WITH 32GB SD CARD
- › WHITE HOT/BLACK HOT/GREEN HOT/IRON RED/RED HOT/SEPHIA
- › DISTANCE CALCULATION VIA VIDEO ANALYSIS
- › PHOTO AND VIDEO RECORDING FUNCTION
- › FIRE WARNING FUNCTION WITH ALARM
- › WATERPROOF

DETECTION RANGE (STANDARD CAR SIZE)	3900 M 12795.2 FT
DETECTION RANGE (AVERAGE HUMAN SIZE)	1800 M 5905.5 FT
RECOGNITION RANGE (STANDARD CAR SIZE)	1000 M 3280.84 FT
RECOGNITION RANGE (AVERAGE HUMAN SIZE)	460 M 1509.19 FT
IDENTIFICATION RANGE (STANDARD CAR SIZE)	500 M 1509.19 FT
IDENTIFICATION RANGE (AVERAGE HUMAN SIZE)	230 M 754.5 FT
WEIGHT (GR/OZ)	318 GR 11.21 OZ
LENGTH	151.7 MM 5.98"

THE THERMAL PRIMACY

Engineered with a magnesium body that minimizes its weight, this monocular is much more compact and portable than any other comparable option in the marketplace.

And yet its reduced size packs an unparalleled visual performance that literally outclasses the competition in terms of resolution (640x512), zoom magnification power (3x-24x), number of palettes (6) and OLED display (1440x1080).

This model is therefore the choice of demanding professionals that are not accustomed to cut corners when it comes to their equipment, because they simply need to have the best of the best.

FLAME 1.5X - 3X



#7954 1.5X-3X ZOOM

4 SELECTABLE PALETTES



THERMAL MODULE		SMART FUNCTION	
IMAGE SENSOR	Vanadium Oxide Uncooled Focal Plane Arrays	HIGHEST TEMPERATURE SPOT TRACKING	YES
MAX RESOLUTION	384X288	WI-FI HOT SPOT	YES
PIXEL INTERVAL	8µm to 14µm	STAND-BY MODE	YES
RESPONSE WAVEBAND	8 µm to 14 µm	SYSTEM	
NETD	Less Than 35mk), F#=1.0	STORAGE	BUILT-IN MEMORY 8GB
LENS (FOCAL LENGTH)	15mm	RECORD VIDEO	YES
FIELD OF VIEW	24.55°x18.9° (HxV)	CAPTURE SNAPSHOT	YES
DIGITAL ZOOM	FROM 1.4X TO 3X	POWER SUPPLY	
APERTURE	F1,0	BATTERY TYPE	Built-in 18650 Lithium Battery
MAGNIFICATION	FROM 1.4x TO 3x	BATTERY OPERATING TIME	7.5 HRS continuously running with CVBS and WI-FI hot spot off ()
IMAGE DISPLAY		BATTERY CAPACITY DISPLAY	YES
MONITOR	0.39 inches, OLED, 1024x768	GENERAL	
FFC (FLAT FIELD CORRECTION)	AUTO, MANUAL, EXTERNAL CORRECTION	POWER	5VDC/2 A, 1.5W, Type-C Interface
PALETTES	BLACK HOT, WHITE HOT, RED HOT, FUSION	WORKING TEMPERATURE	FROM -20°C to 55°C (-4°F to 131°F)
FRAME FREQUENCY	50Hz	PROTECTION LEVEL	SUMERSIBLE WATERPROOF RATING IP-67
		DIMENSIONS	158.3mm x 61mm x 57mm (6.23" x 2.40" x 2.24")
		WEIGHT	250g (0.55 lb)

FEATURES

- › HANDHELD THERMAL MONOCULAR CAMERA
- › 384X288 PIXELS RESOLUTION, HIGH SENSITIVITY DETECTOR
- › BUILT-IN RECHARGEABLE LITHIUM BATTERY
- › WI-FI HOT SPOT
- › ZOOM MAGNIFICATION FROM 1.5X TO 3X
- › 8GB INTERNAL MEMORY
- › WATERPROOF UP TO 3.3FT DEPTH
- › PHOTO AND VIDEO RECORDING FUNCTION

DETECTION RANGE (STANDARD CAR SIZE)	1353 M 1479.6 YDS
DETECTION RANGE (AVERAGE HUMAN SIZE)	400 M 437.44 YDS
RECOGNITION RANGE (STANDARD CAR SIZE)	338 M 369.9 YDS
RECOGNITION RANGE (AVERAGE HUMAN SIZE)	110 M 120.2 YDS
IDENTIFICATION RANGE (STANDARD CAR SIZE)	169 M 184.8 YDS
IDENTIFICATION RANGE (AVERAGE HUMAN SIZE)	55 M 69.1 YDS
WEIGHT (GR/OZ)	250 GR 8.81 OZ
LENGTH	158.3 MM 6.23"

THE THERMAL SUPERIORITY

An ideal choice for professional users, our #7954 model is engineered to maximize any on-field visual experience with a truly remarkable 384x288 resolution that goes way beyond the standards of the market. It also features a very powerful 1.5x-3x zoom system and a generous 8GB internal memory that will accomodate all of your needs while taking pictures and recording videos.



FLAME 0.6X - 2.4X



#7953 0.6x - 2.4x ZOOM

4 SELECTABLE PALETTES

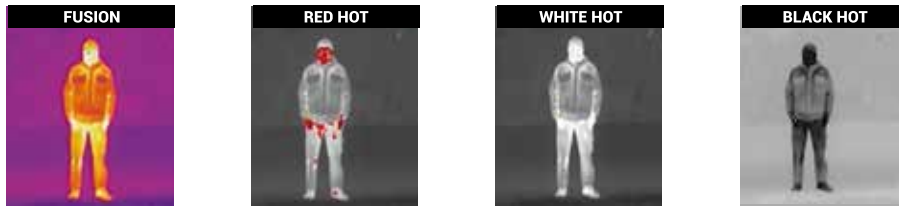

THERMAL MODULE		SMART FUNCTION	
IMAGE SENSOR	Vanadium Oxide Uncooled Focal Plane Arrays	HIGHEST TEMPERATURE SPOT TRACKING	YES
MAX RESOLUTION	160x120	WI-FI HOT SPOT	YES
PIXEL INTERVAL	17µm	STAND-BY MODE	YES
RESPONSE WAVEBAND	8 µm to 14 µm	SYSTEM	
NETD	Less Than 35mk (@25°C), F#=1.0	STORAGE	BUILT-IN MEMORY 8GB
LENS (FOCAL LENGTH)	6.2mm	RECORD VIDEO	YES
FIELD OF VIEW	14.7°x18.7° (HxV)	CAPTURE SNAPSHOT	YES
DIGITAL ZOOM	da 0,6X a 2,4X	POWER SUPPLY	
APERTURE	F1,0	BATTERY TYPE	Built-in 18650 Lithium Battery
MAGNIFICATION	DA 0.6 a 2.4	BATTERY OPERATING TIME	7.5 HRS continuously running with CVBS and WI-FI hot spot off (@25°C)
IMAGE DISPLAY		BATTERY CAPACITY DISPLAY	YES
MONITOR	0.2 NCHES, LCOS, 720x540	GENERAL	
FFC (FLAT FIELD CORRECTION)	AUTO, MANUAL, EXTERNAL CORRECTION	POWER	5VDC/2 A, 1.5W, Type-C Interface
PALETTES	BLACK HOT, WHITE HOT, RED HOT, FUSION	WORKING TEMPERATURE	FROM -20°C to 55°C (-4°F to 131°F)
FRAME FREQUENCY	50Hz	PROTECTION LEVEL	SUMERSIBLE WATERPROOF RATING IP-67
		DIMENSIONS	158.3mm x 61mm x 57mm (6.23" x 2.40" x 2.24")
		WEIGHT	250g (0.55 lb)

FEATURES

- › HANDHELD THERMAL MONOCULAR CAMERA
- › 160X120 PIXELS RESOLUTION, HIGH SENSITIVITY DETECTOR
- › BUILT-IN RECHARGEABLE LITHIUM BATTERY
- › WI-FI HOT SPOT
- › ZOOM MAGNIFICATION FROM 0.6X TO 2.4X
- › 8GB INTERNAL MEMORY
- › WATERPROOF UP TO 3.3FT DEPTH
- › PHOTO AND VIDEO RECORDING FUNCTION

DETECTION RANGE (STANDARD CAR SIZE)	559 M 1833.9 FT
DETECTION RANGE (AVERAGE HUMAN SIZE)	200 M 656.1 FT
RECOGNITION RANGE (STANDARD CAR SIZE)	140 M 459.3 FT
RECOGNITION RANGE (AVERAGE HUMAN SIZE)	46 M 150.9 FT
IDENTIFICATION RANGE (STANDARD CAR SIZE)	70 M 229.6 FT
IDENTIFICATION RANGE (AVERAGE HUMAN SIZE)	23 M 75.4 FT
WEIGHT (GR/OZ)	250 GR 8.81 OZ
LENGTH	158,3 MM 6.23"

THE THERMAL EXCELLENCE

While being very competitively priced, our #7953 model is among the most versatile of the market. It lets you choose between 4 different palettes, it comes with a photo/video recording function and it is also able to transfer the thermal images via Wi-Fi, so that you can see them live on your cellphone if you want. And, having a 0.6x-2.4x zoom system and a bigger display with enhanced field of view, this unit dramatically outperforms the competition from an optical standpoint as well.



NIGHT VISION SYSTEMS

Konus puts at your disposal multiple devices that will enable you to clearly see in total darkness by virtue of the most sophisticated digital technology.

These models are therefore an ideal equipment for hunting, surveillance and wildlife observations in low-light environments.



KONUSPY-19



BUILT-IN
FLASHLIGHT



#7940 1.5x-12x ZOOM

FEATURES

- › 1.5X MAGNIFICATION POWER W/1X-8X DIGITAL ZOOM
- › BUILT-IN IR ILLUMINATOR
- › PHOTO AND VIDEO RECORDING FUNCTION
- › 4K IMAGE RESOLUTION WITH ULTRA-HD ENHANCEMENT
- › TWO BUILT-IN RECHARGEABLE LITHIUM BATTERIES
- › BUILT-IN FLASHLIGHT WITH NORMAL AND FLASHING MODE
- › SUPPLIED WITH USB CABLE AND 8GB SD-CARD
- › DAYTIME AND NIGHTTIME USE
- › WORKING DISTANCE IS 400 METERS OR 450 YARDS
- › TRIPOD ATTACHMENT
- › DAYLIGHT VISION FILTER
- › SOFTWARE IN 14 LANGUAGES

CODE	7940
MODEL	KONUSPY-19
TYPE	NIGHT VISION BINOCULAR
MAGNIFICATION	1.5X - 12X DIGITAL ZOOM
OBJECTIVE Ø	25 MM
FIELD OF VIEW AT 1000M/YDS	175M 574.1 FT
MAXIMUM DISTANCE OF OBSERVATION	400 M 450 YDS
WEIGHT GR/OZ	775 G 27.33 OZ
TRIPOD ADAPTABLE	YES

NIGHT VISION BINOCULAR WITH ULTRA-HD TECHNOLOGY

Engineered with the most advanced electro-optical sensors, this model provides breath-taking images with true High-Definition brightness, contrast and resolution. This kind of visual quality is unprecedented in the Night Vision category and makes this device an ideal choice for demanding professionals that need to excel in a totally dark environment. Other remarkable features are also included, such as an especially generous 1.5x-12x zoom power, a flashlight and a photo/video recording function.



#7939 6x-36x ZOOM

FEATURES

- › 6X-12X-18X POWER WITH 2X DIGITAL ZOOM
- › DAYTIME AND NIGHTTIME USE
- › BUILT-IN ILLUMINATOR FOR TOTAL DARKNESS
- › 3 PAlettes: COLOR-BLACK/WHITE-GREEN
- › PHOTO AND VIDEO RECORDING FUNCTION
- › DIGITAL CROSSHAIR FOR RANGE-FINDING PURPOSES
- › AUTO SHUT-OFF
- › IMAGE RESOLUTION: 1920X1080
- › SUPPLIED WITH USB CABLE AND 8GB SD-CARD
- › TRIPOD ATTACHMENT

CODE	7939
MODEL	KONUSPY-18
TYPE	DIGITAL NIGHT VISION MONOCULAR
MAGNIFICATION	6X-36X ZOOM
OBJECTIVE Ø	32 MM
FIELD OF VIEW AT 1000M/YDS	87.5 M 287 FT
MAXIMUM DISTANCE OF OBSERVATION	400 M 450 YDS
WEIGHT GR/OZ	290 GR 10.22 OZ
TRIPOD ADAPTABLE	YES

THE MOST POWERFUL NIGHT VISION MONOCULAR

This digital monocular will dramatically outperform any competing model in terms of power.

Its zoom system is able to generate a tremendous 6x-36x magnification, which is unprecedented in the Night Vision industry.

Other notable features include a built-in illuminator for total darkness and an internal SD card for taking pictures and recording videos.



#7938 1x-8x ZOOM

FEATURES

- › DIGITAL NIGHT VISION BINOCULAR 1X - 8X ZOOM
- › PHOTO AND VIDEO RECORDING FUNCTION
- › SUPPLIED WITH A/V CABLE, USB CABLE AND 8GB SD-CARD FOR IMAGE STORING PURPOSES
- › STRAP AND CASE INCLUDED
- › WORKS WITH A 18650 RECHARGEABLE BATTERY
- › IMAGE RESOLUTION 1920X1080
- › TRIPOD ATTACHMENT
- › DAYTIME AND NIGHTTIME USE

CODE	7938
MODEL	KONUSPY-17
TYPE	NIGHT VISION BINOCULAR
MAGNIFICATION	1X - 8X DIGITAL ZOOM
OBJECTIVE Ø	25 MM
FIELD OF VIEW AT 1000M/YDS	175M 574.1 FT
MAXIMUM DISTANCE OF OBSERVATION	300 M 984 FT
WEIGHT GR/OZ	300 G 10.5 OZ
TRIPOD ADAPTABLE	YES

SUPREMELY AFFORDABLE NIGHT VISION BINOCULAR

The especially complex technology of Night Vision optics has never been so accessible, especially in the case of a binocular version. This unit will replicate the visual performance of much more professional models at a fraction of their cost, while also putting at your disposal plenty of other exciting features. Its most remarkable asset is certainly the photo and video recording function, which is extremely useful for surveillance purposes.

KONUSPY-12 • KONUSPY-14



#7933 5x-40x ZOOM



#7935 1x-5x ZOOM

FEATURES #7933

- › 5X-40X MAGNIFICATION
- › PHOTO AND VIDEO RECORDING FUNCTION
- › DAYTIME AND NIGHTTIME USE
- › DAYTIME VISION IN COLOUR
- › PC CONNECTABLE
- › SD-CARD FOR STORING IMAGES
- › 5X OPTICAL ZOOM
- › 8X DIGITAL ZOOM
- › TRIPOD ATTACHMENT
- › CASE INCLUDED
- › WORKS WITH THREE AA BATTERIES
- › BUILT-IN ILLUMINATOR FOR TOTAL DARKNESS
- › WORKING DISTANCE: 200M - 220 YDS

CODE	7933	7935
MODEL	KONUSPY-12	KONUSPY-14
TYPE	NIGHT VISION MONOCULAR	NIGHT VISION MONOCULAR
MAGNIFICATION	5X - 40X ZOOM	1X-5X
OBJECTIVE Ø	32 MM	28 MM
FIELD OF VIEW AT 1000M/YDS	88 M 288.7 FT	33.3 M 109.2 FT
MAXIMUM DISTANCE OF OBSERVATION	200 M 218 YDS	300 M 328 YDS
WEIGHT GR/OZ	295 GR 10.4 OZ	186.5 GR 6.58 OZ
TRIPOD ADAPTABLE	YES	YES

FEATURES #7935

- › NIGHT VISION MONOCULAR
- › 1X-5X ZOOM MAGNIFICATION POWER
- › BUILT-IN IR ILLUMINATOR WITH 7 BRIGHTNESS LEVELS
- › PHOTO AND VIDEO RECORDING FUNCTION
- › IMAGE RESOLUTION 1920X1080
- › SUPPLIED WITH USB CABLE AND 8GB SD CARD FOR IMAGE STORING PURPOSES
- › WORKS WITH 5 AA BATTERIES 1.5V (INCLUDED)



#7932 3x-4.5x-6x ZOOM

FEATURES

- › 3X- 4.5X - 6X MAGNIFICATION POWER WITH DIGITAL ZOOM
- › PHOTO AND VIDEO RECORDING FUNCTION
- › SUPPLIED WITH A/V CABLE, USB CABLE AND 8GB SD-CARD FOR IMAGE STORING PURPOSES
- › STRAP AND CASE INCLUDED
- › RUBBER COVERED BODY
- › TRIPOD ATTACHMENT
- › DAYTIME AND NIGHTTIME USE
- › DAYLIGHT VISION FILTER
- › BUILT-IN ILLUMINATOR FOR TOTAL DARKNESS
- › WORKING DISTANCE: 200 M - 220 YDS

CODE	7932
MODEL	KONUSPY-11
TYPE	DIGITAL NIGHT VISION BINOCULAR
MAGNIFICATION	3X-4.5X-6X ZOOM
OBJECTIVE Ø	32 MM
FIELD OF VIEW AT 1000M/YDS	92 M 301.8 FT
MAXIMUM DISTANCE OF OBSERVATION	200 M 218 YDS
WEIGHT GR/OZ	430 GR 15.1 OZ
TRIPOD ADAPTABLE	YES

SUPER COMPACT NIGHT VISION BINOCULAR

The reduced dimensions (7"x5.5" or 18x13.5cm) and weight (18oz or 520 gr) of this digital Night Vision binocular are unparalleled in its entire category and make for an extremely compact and portable unit.

Suitable for both daytime and nighttime use, it comes with 3x-4.5x-6x zoom power and with an internal SD card for taking pictures and recording videos.



BINOCULARS

Konus binoculars are made with an uncompromising commitment to quality at its highest standards. Their superior components ensure the ultimate viewing experience for every demanding user.

Featuring a wide assortment of models with distinctive specifications (compact, zoom, waterproof, etc.), our lines of binoculars have become the favourite choice of avid hunters, birdwatchers and outdoorsmen.



#2272 8x42 W.A.

#2273 10x42 W.A.

FEATURES

- › HD OPTICAL SYSTEM
- › WATERPROOF
- › BAK-4 PRISMS
- › WIDE ANGLE
- › MULTI-COATED OPTICS
- › LARGE EYEPIECES
- › LONG EYE RELIEF

CODE	2272	2273
MODEL	REGENT	REGENT
TYPE	ROOF PRISMS	ROOF PRISMS
MAGNIFICATION PER Ø OBJECTIVE	8X42 W.A.	10X42 W.A.
FOCUSING	CENTRAL	CENTRAL
FIELD OF VIEW AT 1000M/YDS	110 M - 331 FT	102 M - 305 FT
EXIT PUPIL MM	5,2 MM	4 MM
WEIGHT GR/OZ	700 GR 24.6 OZ	700 GR 24.6 OZ
TRIPOD ADAPTABLE	SI	SI

THE HD PERFORMANCE

These binoculars have been developed with a High-Definition optical system that provides an undeniable advantage in terms of brightness and sharpness of the image, while also enhancing the light transmission in less than favorable conditions.

Fully waterproof, they are built with professional Bak-4 prisms and also come with multi-coating treatment.

KONUSREX



#2346 10x50 W.A.

#2347 12x50 W.A.

FEATURES

- › PHASE CORRECTED
- › OPEN HINGE CONSTRUCTION
- › BAK-4 PRISMS
- › FULLY MULTI COATED OPTICS
- › NITROGEN FILLED
- › LARGE EYEPIECES
- › LONG EYE RELIEF
- › WATERPROOF
- › RUBBER COVERED
- › CENTRAL FOCUS
- › SILVER MIRROR COATING
- › SUPER LIGHT WEIGHT
- › EXTRA LARGE EYEPIECES

CODE	2346	2347
MODEL	KONUSREX	KONUSREX
TYPE	ROOF PRISM OPEN HINGE	ROOF PRISM OPEN HINGE
MAGNIFICATION PER Ø OBJECTIVE	10X50 W.A.	12X50 W.A.
FOCUSING	CENTRAL	CENTRAL
FIELD OF VIEW AT 1000M/YDS	101 M 303FT	86 M 258 FT
EXIT PUPIL MM	5.2 MM	4.1 MM
WEIGHT GR/OZ	650 GR 22.8 OZ	650 GR 22.8 OZ
TRIPOD ADAPTABLE	YES	YES

THE SILVER MIRROR COATING REVOLUTION

The absolute top of the line among Konus binoculars, the Konusrex series features the incomparable resolution and brilliance of the Silver Mirror Coating treatment, thus achieving a light transmission as high as 96%. The outstanding optical performance of these binoculars is further enhanced by the fully multi-coated lenses with Phase Correction and professional BAK-4 prisms.



#2344 8x42 W.A.

#2345 10x42 W.A.

FEATURES

- › PHASE CORRECTED
- › OPEN HINGE CONSTRUCTION
- › BAK-4 PRISMS
- › FULLY MULTI COATED OPTICS
- › NITROGEN FILLED
- › LARGE EYEPIECES
- › LONG EYE RELIEF
- › WATERPROOF
- › RUBBER COVERED
- › CENTRAL FOCUS
- › SILVER MIRROR COATING
- › SUPER LIGHT WEIGHT
- › EXTRA LARGE EYEPIECES

CODE	2344	2345
MODEL	KONUSREX	KONUSREX
TYPE	ROOF PRISM OPEN HINGE	ROOF PRISM OPEN HINGE
MAGNIFICATION PER Ø OBJECTIVE	8X42 W.A.	10X42 W.A.
FOCUSING	CENTRAL	CENTRAL
FIELD OF VIEW AT 1000M/YDS	124 M 371 FT	106 M 319 FT
EXIT PUPIL MM	5.2 MM	4.2 MM
WEIGHT GR/OZ	550 GR 19.4 OZ	550 GR 19.4 OZ
TRIPOD ADAPTABLE	YES	YES

THE SILVER MIRROR COATING REVOLUTION

The absolute top of the line among Konus binoculars, the Konusrex series features the incomparable resolution and brilliance of the Silver Mirror Coating treatment, thus achieving a light transmission as high as 96%.

The outstanding optical performance of these binoculars is further enhanced by the fully multi-coated lenses with Phase Correction and professional BAK-4 prisms.

EMPEROR



#2340 12x50 W.A.



#2336 10x42 W.A.

FEATURES

- › CLOSE FOCUS
- › PHASE CORRECTED
- › BAK-4 PRISMS
- › NITROGEN FILLED
- › SUPER WIDE ANGLE
- › EXTRA LARGE EYEPIECES
- › LONG EYE RELIEF
- › RUBBER COVERED

CODE	2340	2336
MODEL	EMPEROR	EMPEROR
TYPE	ROOF PRISMS	ROOF PRISMS
MAGNIFICATION PER Ø OBJECTIVE	12X50 W.A.	10X42 W.A.
FOCUSING	CENTRAL	CENTRAL
FIELD OF VIEW AT 1000M/YDS	80 M 262 FT	98 M 314.9 FT
EXIT PUPIL MM	4.1 MM	4.1 MM
WEIGHT GR/OZ	900 GR 31.7 OZ	760 GR 6.8 OZ
TRIPOD ADAPTABLE	YES	YES

HIGH END BINOCULARS WITH PHASE CORRECTION

Widely considered some of the best binoculars in the industry, our Emperor models have generated unprecedented enthusiasm among the most demanding users.

Never before a model with Phase Corrected optics has been so affordable, thus delivering the most outstanding combination of performance and value.



#2327 8x42 W.A.

#2328 10x42 W.A.

FEATURES

- › LONG EYE RELIEF
- › BAK-4 PRISMS
- › MULTI COATED OPTICS
- › FOGPROOF
- › RUBBER COVERED
- › OPEN HINGE CONSTRUCTION
- › LARGE EYEPIECES

CODE	2327	2328
MODEL	TITANIUM OH	TITANIUM OH
TYPE	ROOF PRISM OPEN HINGE	ROOF PRISM OPEN HINGE
MAGNIFICATION PER Ø OBJECTIVE	8X42 W.A.	10X42 W.A.
FOCUSING	CENTRAL	CENTRAL
FIELD OF VIEW AT 1000M/YDS	122 M 366 FT	98 M 294 FT
EXIT PUPIL MM	4.6 MM	3.7 MM
WEIGHT GR/OZ	450 GR 15.8 OZ	450 GR 15.8 OZ
TRIPOD ADAPTABLE	NO	NO

HIGH END BINOCULARS WITH SUPER LIGHT BODY

Highly touted by the most demanding customers due to their spectacular optical quality, the Titanium binoculars are now better looking than ever. Our newest 8x42 and 10x42 models feature a modern and sleek open hinge design that enhances their appearance while maximizing their portability.

ABYSS • TORNADO



#2301 ABYSS 7x50 C.F.



#2325 TORNADO 7x50 I.F.

COMPASS
& RETICLE

FEATURES

- › WATERPROOF/FOGPROOF
- › NITROGEN FILLED
- › BAK-4 PRISMS
- › SPECIAL COATED OPTICS
- › RUBBER COVERED
- › BUILT-IN COMPASS AND ILLUMINATED RETICLE (#2325)
- › FLOATING BODY (#2325)
- › DARK GREEN COATING ON EYEPIECES AND OBJECTIVES (#2301)
- › ENLARGED EYEPIECES (#2301)
- › ROLL-DOWN EYECUPS (#2301)

CODE	2301	2325
MODEL	ABYSS	TORNADO
TYPE	WATERPROOF	WATERPROOF WITH COMPASS
MAGNIFICATION PER Ø OBJECTIVE	7X50	7X50
FOCUSING	CENTRAL	INDIVIDUAL
FIELD OF VIEW AT 1000M/YDS	112 M 367 FT	132 M 433 FT
EXIT PUPIL MM	7.1 MM	6.8 MM
WEIGHT GR/OZ	950 GR 33.5 OZ	890 GR 31 OZ
TRIPOD ADAPTABLE	YES	YES

WATERPROOF BINOCULARS FOR NAUTICAL AND BOATING PURPOSES

The Konus nautical binoculars deliver a great performance in every marine and boating environment thanks to their waterproof and nitrogen purged construction, coupled with special coated lenses that help cut glare over water or snow.



#2302 7x50

FEATURES

- › WATERPROOF/FOGPROOF
- › NITROGEN FILLED
- › SPECIAL COATED OPTICS
- › RUBBER COVERED
- › BAK-4 PRISMS
- › ENLARGED EYEPIECES
- › ROLL-DOWN EYECUPS
- › STRAP AND CASE INCLUDED

CODE	2302
MODEL	ABYSS-2
TYPE	WATERPROOF
MAGNIFICATION PER Ø OBJECTIVE	7X50
FOCUSING	CENTRAL
FIELD OF VIEW AT 1000M/YDS	112 M 367 FT
EXIT PUPIL MM	7.1 MM
WEIGHT GR/OZ	950 GR 33.5 OZ
TRIPOD ADAPTABLE	YES

WATERPROOF BINOCULARS FOR NAUTICAL AND BOATING PURPOSES

The Konus nautical binoculars deliver a great performance in every marine and boating environment thanks to their waterproof and nitrogen purged construction, coupled with special coated lenses that help cut glare over water or snow.

SPORTY



#2255 7x50

#2256 10x50 W.A.



#2010 TRIPOD ATTACHMENT FOR SPORTY BINOCULARS (SEE PAGES 88-8 FOR TRIPODS)

FEATURES

- › FOCUS FREE
- › GREEN MULTI-COATED OPTICS
- › WIDE ANGLE (#2256)
- › RUBBER COVERED
- › IDEAL FOR LOOKING AT FAST MOVING OBJECTS

CODE	2255	2256
MODEL	SPORTY	SPORTY
TYPE	PORRO PRISMS	PORRO PRISMS
MAGNIFICATION PER Ø OBJECTIVE	7X50	10X50 W.A
FOCUSING	FOCUS FREE	FOCUS FREE
FIELD OF VIEW AT 1000M/YDS	122 M 366 FT	96 M 288 FT
EXIT PUPIL MM	7.1 MM	5 MM
WEIGHT GR/OZ	800 GR 28.2 OZ	770 GR 27 OZ
TRIPOD ADAPTABLE	YES	YES

FOCUS FREE BINOCULARS FOR FAST MOVING TARGETS

The Sporty binoculars stand out because of their competitive price and because of their special focus free construction that enables them to automatically focus on every target from a set distance on without any manual adjustment.



#2171 7x50 C.F.



#2170 8x42 W.A.

#2172 10x50 W.A.

FEATURES

- › BAK-4 PRISMS
- › CENTRAL FOCUSING
- › EXTRA LARGE EYEPIECES
- › WIDE ANGLE
- › MULTICOATED OPTICS
- › RUBBER COVERED

CODE	2170	2171	2172
MODEL	KONUSARMY	KONUSARMY	KONUSARMY
TYPE	PORRO PRISMS	PORRO PRISMS	PORRO PRISMS
MAGNIFICATION PER Ø OBJECTIVE	8X42 W.A.	7X50 C.F.	10X50 W.A.
FOCUSING	CENTRAL	CENTRAL	CENTRAL
FIELD OF VIEW AT 1000M/YDS	140 M 459 FT	110 M 361 FT	112 M 367 FT
EXIT PUPIL MM	4.5 MM	6.7 MM	4.7 MM
WEIGHT GR/OZ	845 GR 29.8 OZ	970 GR 34.2 OZ	970 GR 34.2 OZ
TRIPOD ADAPTABLE	YES	YES	YES

CLASSICAL BINOCULARS WITH MILITARY DESIGN

This brand new product stands out as a true military binocular in both its classical design and its remarkable specifications, which make it an ideal choice for every sportsman and professional that is looking for rugged and highly performing equipment that will never let him down.

KONUSVUE



#2101 8x40 W.A.



#2102 7x50 C.F.
#2103 10x50 W.A.

FEATURES

- › COATED OPTICS
- › WIDE ANGLE (#2101 AND #2103)
- › RUBBER COVERED
- › CENTRAL FOCUS
- › COMPETITIVELY PRICED
- › LIGHTWEIGHT BODY

CODE	2101	2102	2103
MODEL	KONUSVUE	KONUSVUE	KONUSVUE
TYPE	PORRO PRISMS	PORRO PRISMS	PORRO PRISMS
MAGNIFICATION PER Ø OBJECTIVE	8X40 W.A.	7X50 C.F.	10X50 W.A.
FOCUSING	CENTRAL	CENTRAL	CENTRAL
FIELD OF VIEW AT 1000M/YDS	143 M 476 FT	119 M 396 FT	122 M 406 FT
EXIT PUPIL MM	5 MM	7.1 MM	4 MM
WEIGHT GR/OZ	530 GR 18.6 OZ	750 GR 26 OZ	800 GR 28 OZ
TRIPOD ADAPTABLE	YES	YES	YES

RUGGED AND DEPENDABLE BINOCULARS

Although very competitively priced, the Konusvue binoculars have a good optical quality, a strong full-metal construction and a sturdy rubber armouring for superior gripping capability even while wearing gloves.



#2124 10-30x60 C.F.



#2122 8-24x50 C.F.



#2120 7-21x40 C.F.

FEATURES

- › RUBBER COVERED
- › CENTRAL FOCUS
- › COATED OPTICS
- › ZOOM POWER

CODE	2124	2122	2120
MODEL	NEWZOOM	NEWZOOM	NEWZOOM
TYPE	ZOOM	ZOOM	ZOOM
MAGNIFICATION PER Ø OBJECTIVE	10-30X60 ZOOM	8-24X50 ZOOM	7-21X40 ZOOM
FOCUSING	CENTRAL	CENTRAL	CENTRAL
FIELD OF VIEW AT 1000M/YDS	78M - 234 FT AT 10X 35 M - 105 FT AT 30X	78 M - 234 FT AT 8X 40M - 131 FT AT 24X	96 M - 314 FT AT 7X 43 M - 129 FT AT 21X
EXIT PUPIL MM	6 MM AT 10X 2 MM AT 30X	6.2 MM AT 8X 2.1 MM AT 24X	5.7 MM AT 7X 1.9 MM AT 21X
WEIGHT GR/OZ	1380 GR 49.2 OZ	900 GR 31.7 OZ	800 GR 28.3 OZ
TRIPOD ADAPTABLE	YES	YES	YES

THE INCOMPARABLE VERSATILITY OF ZOOM BINOCULARS

The Konus Newzoom line is available in 3 diameters with different power in order to match every user's needs. These binoculars also feature a strong and rugged body with rubber armour and crisp optical quality.

GIANT



#2110 20x80



#2022
UNIVERSAL TRIPOD
ATTACHMENT FOR
BINOCULARS (SEE PAGES
88-89 FOR TRIPODS)



FEATURES

- › COATED OPTICS
- › WIDE DIAMETER
- › RUBBER COVERED
- › CENTRAL FOCUS
- › PROFESSIONAL TRIPOD ATTACHMENT (#2110)

CODE	2110	2125
MODEL	GIANT-80	GIANT-60
TYPE	PORRO PRISMS	PORRO PRISMS
MAGNIFICATION PER Ø OBJECTIVE	20X80	20X60
FOCUSING	CENTRAL	CENTRAL
FIELD OF VIEW AT 1000M/YDS	48 M 157 FT	38 M 124 FT
EXIT PUPIL MM	3.83 MM	3 MM
WEIGHT GR/OZ	2500 GR 88.1 OZ	1300 GR 45.8 OZ
TRIPOD ADAPTABLE	YES	YES

HIGH POWERED BINOCULARS WITH LARGE DIAMETERS

Two giant binoculars with 20x magnification power and impressive 60mm and 80mm objectives. Built to maximize the field of view and provide an outstanding panoramic vision, they are ideal for astronomy and birdwatching. Due to their dimensions, they are quite heavy and it is therefore recommended to use them with a tripod.



#2006 10x42

FEATURES

- › MULTI-COATED OPTICS
- › CENTRAL FOCUS
- › RUBBER COVERED
- › TRIPOD ATTACHMENT
- › CASE AND STRAP INCLUDED

CODE	2006
MODEL	BASIC-PLUS
TYPE	ROOF PRISM
MAGNIFICATION PER Ø OBJECTIVE	10X42
FOCUSING	CENTRAL
FIELD OF VIEW AT 1000M/YDS	87 M 285.4 FT
EXIT PUPIL MM	5.1 MM
WEIGHT GR/OZ	484 G 17.07 OZ
TRIPOD ADAPTABLE	YES

ROOF PRISM BINOCULARS AT A PRICE THAT CAN'T BE BEAT

While also featuring a noteworthy optical quality and a stylish design, this model truly stands out because of its supremely competitive price. It is therefore a tremendous value for every sportsman or nature enthusiast on a budget.

SUPREME-2



#2363 8x26 W.A.

#2364 10x26 W.A.

FEATURES

- › CENTRAL FOCUS
- › FULLY MULTI-COATED OPTICS
- › ERGONOMIC DESIGN
- › WIDE ANGLE
- › RUBBER COVERED
- › WATERPROOF
- › BAK-4 PRISMS
- › OPEN HINGE CONSTRUCTION

CODE	2363	2364
MODEL	SUPREME- 2	SUPREME- 2
TYPE	COMPACT WATERPROOF	COMPACT WATERPROOF
MAGNIFICATION PER Ø OBJECTIVE	8X26 W.A.	10X26 W.A.
FOCUSING	CENTRAL	CENTRAL
FIELD OF VIEW AT 1000M/YDS	123 M 403 FT	103 M 337 FT
EXIT PUPIL MM	3.25 MM	2.6 MM
WEIGHT GR/OZ	305 GR 10.7 OZ	325 GR 11.4 OZ
TRIPOD ADAPTABLE	NO	NO

WATERPROOF COMPACT BINOCULARS

Waterproof and nitrogen purged, these binoculars will perform flawlessly even in the most challenging weather conditions.

The # 2363 and # 2364 are high end models with BAK-4 prisms, fully multi-coated optics, extra wide eyepieces and long eye relief.



#2306 VIVISPORT-25 10x25

FEATURES

- › WATERPROOF
- › 25MM OBJECTIVE DIAMETER (#2306)
- › 26MM OBJECTIVE DIAMETER (#2365-66)
- › MULTICOATED LENSES
- › CENTRAL FOCUS
- › RUBBER COVERED
- › CASE AND STRAP INCLUDED
- › BAK-4 PRISMS (#2365-66)
- › OPEN HINGE CONSTRUCTION (#2365-66)

CODE	2306
MODEL	VIVISPORT-25
TYPE	COMPACT WATERPROOF
MAGNIFICATION PER Ø OBJECTIVE	10X25
FOCUSING	CENTRAL
FIELD OF VIEW AT 1000M/YDS	100.8 M 331 FT
EXIT PUPIL MM	2.5 MM
WEIGHT GR/OZ	317.5 GR 11.2 OZ
TRIPOD ADAPTABLE	NO

COMPACT WATERPROOF BINOCULARS AT AN UNBEATABLE PRICE

The # 2306 is in class by itself, because never before has a compact binocular been so affordable. And its appearance is top notch as well, by virtue of its unique and captivating design.

VIVISPORT - ZOOMY-25



#2040 VIVISPORT-2 16x32



#2059 ZOOMY-25 8-17x25

FEATURES

- › CENTRAL FOCUS
- › SPECIAL COATING
- › RUBBER COVERED (#2040)
- › ERGONOMIC DESIGN
- › 16X MAGNIFICATION (#2040)
- › ZOOM SYSTEM (#2059)
- › PVC BODY (#2059)

CODE	2040	2059
MODEL	VIVISPORT 2	ZOOMY-25
TYPE	COMPACT	COMPACT ZOOM
MAGNIFICATION PER Ø OBJECTIVE	16X32	8-17X25
FOCUSING	CENTRAL	CENTRAL
FIELD OF VIEW AT 1000M/YDS	82 M 366 FT	80 M/262 FT AT 8X 46 M/150 FT AT 17X
EXIT PUPIL MM	2.6 MM	3 MM AT 8X 2 MM AT 17X
WEIGHT GR/OZ	250 GR 8.8 OZ	300 GR 10.5 OZ
TRIPOD ADAPTABLE	NO	NO

COMPACT SIZE BINOCULARS COMBINING POWER AND PORTABILITY

Featuring a modern and stylish design, the #2040 and #2059 binoculars pack a tremendous power into an extremely compact body.



#2019 8x21

#2020 10x25

FEATURES

- › CENTRAL FOCUS
- › GREEN COATED OPTICS
- › RUBBER COVERED

CODE	2019	2020
MODEL	NEXT-2	NEXT-2
TYPE	COMPACT	COMPACT
MAGNIFICATION PER Ø OBJECTIVE	8X21	10X25
FOCUSING	CENTRAL	CENTRAL
FIELD OF VIEW AT 1000M/YDS	124 M 406.8 FT	101 M 331.3 FT
EXIT PUPIL MM	2.6 MM	2.5 MM
WEIGHT GR/OZ	250 GR 8.81 OZ	260 GR 9.17 OZ
TRIPOD ADAPTABLE	NO	NO

COMPACT BINOCULARS WITH EXCLUSIVE DESIGN

These instruments give you the possibility to carry the power of observation anywhere. Their reduced dimensions, the optical quality and the special rubber covering make them indispensable items for travelling, trekking, following sport events and so on.

ACTION - EXPLO



#2041 ACTION 10x25 F.F.



#2023 EXPLO 8x21 C.F.
#2024 EXPLO 10x25 C.F.

FEATURES

- › FIXED FOCUS (#2041)
- › RUBY COATED OPTICS
- › RUBBER COVERED
- › CENTRAL FOCUS (#2023 AND #2024)
- › SPECIAL PACKAGING (#2023 AND #2024)

CODE	2041	2023	2024
MODEL	ACTION	EXPLO	EXPLO
TYPE	COMPACT	COMPACT	COMPACT
MAGNIFICATION PER Ø OBJECTIVE	10X25	8X21	10X25
FOCUSING	FIXED FOCUS	CENTRAL	CENTRAL
FIELD OF VIEW AT 1000M/YDS	80 M 240 FT	126 M 378 FT	100 M 300 FT
EXIT PUPIL MM	2.1 MM	2.6 MM	2.5 MM
WEIGHT GR/OZ	170 GR 5.9 OZ	150 GR 5.3 OZ	200 GR 6.9 OZ
TRIPOD ADAPTABLE	NO	NO	NO

EYE-CATCHING COMPACT BINOCULARS

The #2041 binoculars feature a terrific appearance and have been built with a special focus-free optical system that is ideal for observing fast moving objects.

The #2023 and #2024 binoculars have been developed with an highly captivating and original packaging which will definitely stand out. The product will therefore draw the attention of every potential buyer, while also being protected from shoplifters.



#2007 8x21 C.F.



#2008 10x25
#2009 12x32

FEATURES

- › PACKED IN GIFTBOX
- › RUBY COATED OPTICS
- › RUBBER COVERED
- › CENTRAL FOCUS

CODE	2007	2008	2009
MODEL	BASIC	BASIC	BASIC
TYPE	COMPACT	COMPACT	COMPACT
MAGNIFICATION PER Ø OBJECTIVE	8X21	10X25	12X32
FOCUSING	CENTRAL	CENTRAL	CENTRAL
FIELD OF VIEW AT 1000M/YDS	122 M 366 FT	96 M 288 FT	90 M 270 FT
EXIT PUPIL MM	2.7 MM	2.5 MM	2.5 MM
WEIGHT GR/OZ	230 GR 8.1 OZ	232 GR 8.1 OZ	250 GR 8.8 OZ
TRIPOD ADAPTABLE	NO	NO	NO

THE ESSENTIAL COMPACT BINOCULARS

Regardless of the category you are into, it is always important to count on a line of products that enables you to compete also at the lowest price level.

These binoculars will serve you well for such a purpose, while still featuring a more than satisfactory quality, a great looking packing and some nice cosmetic touches like the silver metal body and the ruby coated lenses.

RF-1200

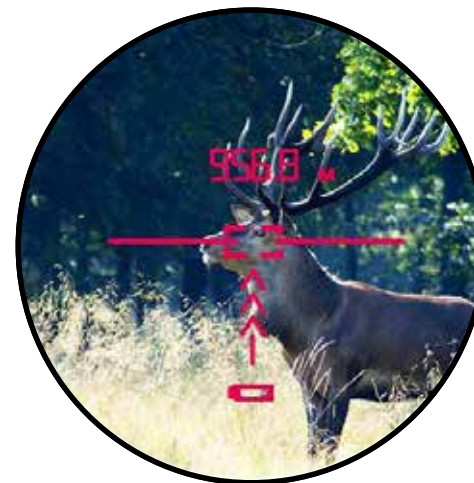

#7316 RF-1200 6x25

FEATURES

- › 6X MAGNIFICATION
- › MEASURING RANGE FROM 5 - 1200M OR 5 - 1320YDS
- › FLAGPOLE LOCK FUNCTION
- › SPEED AND HEIGHT CALCULATION
- › ANGLE COMPENSATION
- › METER/YARD MEASUREMENT
- › SCANNING FUNCTION
- › FOG/RAIN MODE
- › GOLF AND HUNTING MODE
- › STRAP AND CASE INCLUDED
- › SUPER COMPACT SIZE

CODE	7316
MODEL	RF-1200
TYPE	LASER RANGE FINDER
MAGNIFICATION X OBJECTIVE Ø	6X25
MEASURED DISTANCE	5-1200 M 5-1320 YDS
FIELD OF VIEW AT 1000M/YDS	128 M 419.9 FT
ACCURACY	+/- 1M
WEIGHT	158 GR 5.57 OZ
TRIPOD ADAPTABLE	NO

ADVANCED RANGEFINDER FOR THE PROFESSIONALS

This high-end device instantly delivers ultra-precise measurements up to a distance of 1200 meters or 1320 yards. It is especially remarkable for its pocket-sized dimensions, to go along with many other functions that make it an essential tool for hunters and golfers: angle compensation, speed and height calculation, flagpole lock and so forth.



#7317 EVO-1200 6X25

FEATURES

- › 6X MAGNIFICATION
- › MEASURING RANGE FROM 5 - 1200M OR 5 - 1320YDS
- › METER/YARD MEASUREMENT
- › SCANNING FUNCTION
- › FOG/RAIN MODE
- › GOLF AND HUNTING MODE
- › STRAP AND CASE INCLUDED

CODE	7317
MODEL	EVO-1200
TYPE	LASER RANGE FINDER
MAGNIFICATION X OBJECTIVE Ø	6X25
MEASURED DISTANCE	5-1200M 5-1320 YDS
FIELD OF VIEW AT 1000M/YDS	113.6 M 372.7 FT
ACCURACY	+/- 1M
WEIGHT	135 GR 4.76
TRIPOD ADAPTABLE	NO

AFFORDABLE RANGEFINDER WITH PLENTY OF VALUE

An ideal solution when you are trying to save money on a tight budget, this highly competitive model has a maximum distance of 1200 meters or 1320 yards. It also comes with some truly handy features like the scanning function, golf mode and hunting mode, while being optimized to work in foggy



SPOTTING SCOPES

Widely considered to be in a class by themselves, Konus spotting scopes are built to exceed even the highest expectations in terms of performance and value.

Their superior optical quality and their distinctive features are currently unparalleled in the industry, thus making these fine instruments the favourite choice of avid hunters, birdwatchers and outdoorsmen.

KONUSPOT-100



SMARTPHONE
ADAPTER INCLUDED



#7127 20-60x100 ZOOM

FEATURES

- › TRIPOD NOT INCLUDED
- › CAMERA ADAPTER INCLUDED
- › SMARTPHONE ADAPTER INCLUDED
- › PROTECTIVE PROFESSIONAL CASE INCLUDED
- › MULTI-COATED OPTICS

CODE	7127
MODEL	KONUSPOT-100
MAGNIFICATION	20-60X ZOOM
Ø OBJECTIVE	100 MM
FIELD OF VIEW AT 1000M/YDS	29 M - 88 FT AT 20X 15 M - 44 FT AT 60X
EXIT PUPIL MM	5 MM AT 20X 1.67 MM AT 60X
WEIGHT GR/OZ	2097 GR 74 OZ
LENGTH MM/INCHES	498 MM 19.6"

SPOTTING SCOPES WITH UNCOMPROMISING QUALITY

Our acclaimed series of spotting scopes has been completely re-designed in order to amaze even the most demanding users.

With oversized objective lenses and zoom eyepieces, these superb instruments are built to maximize the viewing experience under any light condition.

And they are now richer than ever, since they also include a special adapter for Smartphones that makes them even more versatile.

KONUSPOT-80



PROTECTIVE
PROFESSIONAL CASE
INCLUDED



SMARTPHONE
ADAPTER INCLUDED



TABLE TRIPOD INCLUDED

#7126 20-60x80 ZOOM

FEATURES

- › MULTI COATED OPTICS
- › TABLE TRIPOD INCLUDED
- › SMARTPHONE ADAPTER INCLUDED
- › CAMERA ADAPTER INCLUDED
- › PROTECTIVE PROFESSIONAL CASE INCLUDED

CODE	7126
MODEL	KONUSPOT-80
MAGNIFICATION	20-60X ZOOM
Ø OBJECTIVE	80 MM
FIELD OF VIEW AT 1000M/YDS	26 M - 79 FT AT 20X 14 M - 41 FT AT 60X
EXIT PUPIL MM	2.9 MM AT 20X 1.2 MM AT 60X
WEIGHT GR/OZ	1400 GR 49.3 OZ
LENGTH MM/INCHES	447 MM 17.6"

EQUIPPED WITH EXCLUSIVE SMARTPHONE ADAPTER

On top of its unparalleled optical performance the #7126 spotting scope also brings to the table a remarkably attractive design and plenty of invaluable accessories. In fact this model comes with a table tripod and a protective carrying case, to go along with an exclusive adapter for smartphones that will set it apart from the competition.

KONUSPOT-65



PROTECTIVE
PROFESSIONAL CASE
INCLUDED



SMARTPHONE
ADAPTER INCLUDED



TABLE TRIPOD INCLUDED

#7128 15-45x65 ZOOM

FEATURES

- › MULTI COATED OPTICS
- › TABLE TRIPOD INCLUDED
- › SMARTPHONE ADAPTER INCLUDED
- › CAMERA ADAPTER INCLUDED
- › PROTECTIVE PROFESSIONAL CASE INCLUDED

CODE	7128
MODEL	KONUSPOT-65
MAGNIFICATION	15-45X ZOOM
Ø OBJECTIVE	65 MM
FIELD OF VIEW AT 1000M/YDS	38 M - 115 FT AT 15X 20 M - 59 FT AT 45X
EXIT PUPIL MM	4 MM AT 15X 1.3 MM AT 45X
WEIGHT GR/OZ	898 GR 31.7 OZ
LENGTH MM/INCHES	355.6 MM 14"

SUPERIOR CLARITY AND BRIGHTNESS

More compact and portable than the 80mm and 100mm versions, this 65mm spotting scope is equally spectacular from an optical standpoint and it also includes the very same accessories, starting with the special adapter for Smartphones.

KONUSPOT-50 • KONUSPOT-70B



#7129 KONUSPOT-70B 20-60x70 ZOOM



#7124 KONUSPOT-50 15-40x50 ZOOM

FEATURES

- › MULTI-COATED OPTICS
- › TABLE TRIPOD INCLUDED
- › ZOOM POWER
- › CARRYING CASE INCLUDED
- › EXTENDABLE SUNSHADE TO REDUCE GLARE (#7129)

CODE	7129	7124
MODEL	KONUSPOT-70B	KONUSPOT-50
MAGNIFICATION	20-60X ZOOM	15X-40X ZOOM
Ø OBJECTIVE	70 MM	50 MM
FIELD OF VIEW AT 1000M/YDS	35M - 114FT AT 20X 18.5M - 61 FT AT 60X	50M - 164FT AT 15X 15M - 49FT AT 40X
EXIT PUPIL MM	2.3 MM AT 20X 7.4 MM AT 60X	3.57 MM AT 15X 1.25 MM AT 40X
WEIGHT GR/OZ	1600 GR 56.4 OZ	466 GR 16.4 OZ
LENGTH MM/INCHES	450 MM 17.7"	245 MM 9.6"

VERSATILE AND AFFORDABLE SPOTTING SCOPES

A perfect choice for hunters, birdwatchers and nature enthusiasts with a tight budget, these spotting scopes combine fine optical quality, attractive design and a price that can't be beat.



#4089 KONUSPOINT-6



#4074 KONUSTAR-10



#4075 KONUSTAR-11

FEATURES

#4089 KONUSPOINT-6

- › SET 6 PIECES
- › MARCH COMPASS
- › EXCLUSIVE DESIGN
- › SUPPLIED WITH ITS OWN 6-PIECE DISPLAY BOX
- › COMPACT AND LIGHTWEIGHT

#4074 KONUSTAR-10 - GREY #4075 KONUSTAR-11 - GREEN

- › PROFESSIONAL COMPASS
- › FULL METAL BODY
- › LIQUID FILLED
- › CLINOMETER
- › LEVEL BUBBLE
- › 2 SCALES
- › TRIPOD ATTACHMENT
- › 360° EYEPIECE

COMPASSES WITH MILITARY QUALITY AND TECHNOLOGY

Invented, created and developed by Konus, these compasses are a worldwide exclusivity that only our company can offer you.

The #4074-4075 are professional models with full metal body and plenty of other military features like the clinometer, the level bubble, the tripod attachment and the 360° eyepiece. The # 4089 is a cheaper and more compact version that combines an innovative design with an extremely light weight.

KONUSMALL-3



SMARTPHONE
ADAPTER INCLUDED

#2063 8-24x40 ZOOM

FEATURES

- › 8X-24X ZOOM POWER
- › 40MM OBJECTIVE DIAMETER
- › MULTI-COATED LENSES
- › DUAL FOCUS SYSTEM
- › TRIPOD ATTACHMENT
- › SMARTPHONE ADAPTER
- › CASE INCLUDED

CODE	2063
MODEL	KONUSMALL-3
MAGNIFICATION	8-24X ZOOM
Ø OBJECTIVE	40 MM
FIELD OF VIEW AT 1000M/YDS	80.4 M - 264 FT AT 8X 45.5 M -149.2 FT AT 24X
EXIT PUPIL MM	4.2 MM AT 8X 1.7 MM AT 24X
WEIGHT GR/OZ	156 GR 5.5 OZ
LENGTH MM/INCHES	155 MM 6.1"

ZOOM MONOCULAR WITH SMARTPHONE ADAPTER

A truly revolutionary concept, the #2063 is a high end monocular which provides the dual advantage of a tremendous power and a very reduced size.

It comes with a 8x-24x zoom eyepiece and with an universal Smartphone adapter that will dramatically enrich and expand every user's viewing experience.

KONUSMALL • KONUSMALL-2



#2062 KONUSMALL-2 7-17X30 ZOOM



#2060 KONUSMALL10x25

FEATURES

- › ZOOM MAGNIFICATION FROM 7X TO 17X (#2062)
- › 30MM OBJECTIVE DIAMETER (#2062)
- › MULTI-COATED OPTICS (#2062)
- › DOUBLE FOCUSING SYSTEM (#2062)
- › TRIPOD ATTACHMENT (#2062)
- › ROLL-DOWN EYECUP (#2062)
- › STRAP AND CASE INCLUDED (#2062)
- › SET 6 PIECES (#2060)
- › WITH DISPLAY BOX (#2060)
- › RUBY COATED OPTICS (#2060)
- › RUBBER COVERED (#2060)

CODE	2062	2060
MODEL	KONUSMALL-2	KONUSMALL
MAGNIFICATION	7X-17X ZOOM	10X
Ø OBJECTIVE	30 MM	25 MM
FIELD OF VIEW AT 1000M/YDS	80.5M - 264.1 FT AT 7X 45.5M - 149.2FT AT 17X	100 M 300 FT
EXIT PUPIL MM	4.2 MM AT 7X 1.7 MM AT 17X	2.5 MM
WEIGHT GR/OZ	156 GR 5.5 OZ	60 GR 2.1 OZ
LENGTH MM/INCHES	128 MM 5.03"	113 MM 4.44"

POWERFUL AND POCKET-SIZED

The #2062 is a new high quality monocular with 7x-17x zoom power and 30mm objective diameter. It features a very advanced dual focusing system with quick focusing and fine focusing options. The #2060 is a competitively priced and attractive unit with 10x25 size.

TRIPODS

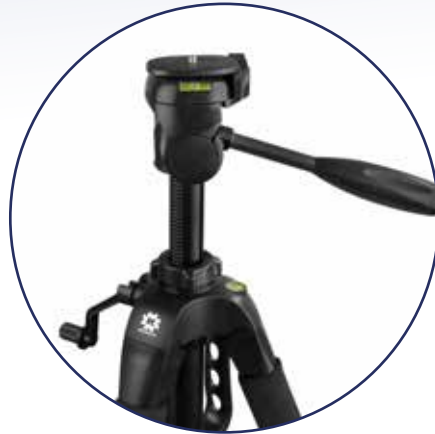

#1960 3-POD-10



#1956 3-POD-6

PROFESSIONAL PHOTOGRAPHIC TRIPODS

A sturdy and dependable tripod is an invaluable companion for every spotting scope and binoculars. Our photographic models come with enhanced resistance and carrying capability, heavy duty legs, quick release mounting system and level bubble.

FEATURES

#1960 3-POD 10

- > HEIGHT 2.29 FT - 5.97 FT (70 - 182 CM)
- > WEIGHT 3.74 LBS - 1.7 KG
- > 3 SECTIONS
- > WITH CARRYING CASE
- > TWO LEVEL BUBBLES
- > QUICK RELEASE PLATFORM
- > ANTI-SLIPPING SPIKED FEET

#1954 3-POD 4

- > 3 SECTIONS
- > WITH CARRYING CASE
- > TWO LEVEL BUBBLES
- > QUICK RELEASE PLATFORM
- > 6 DIFFERENT BLOCKING POSITION FOR MAXIMUM STABILITY
- > HEIGHT 168 CM (5.5 FT)
- > WEIGHT 2.3 KG (5.07 LBS)
- > ANTI SLIPPING SPIKED FEET



#1959 3-POD-9



#1958 3-POD-8

FEATURES

#1959 3-POD 9

- › 3 SECTIONS
- › WITH CARRYING CASE
- › TWO LEVEL BUBBLES
- › 6 DIFFERENT BLOCKING POSITION FOR MAXIMUM STABILITY
- › QUICK RELEASE PLATFORM
- › HEIGHT 137 CM (4.49 FT)
- › WEIGHT 980 GR (34.5 OZ)
- › ANTI SLIPPING SPIKED FEET

#1958 3-POD 8

- › TABLE TRIPOD
- › HEIGHT: 7.8" - 13.7" (20 - 35 CM)
- › WEIGHT 15.5 OZ - 440 GR
- › MICROMETRIC REGULATION
- › ADJUSTABLE HEIGHT

BIPODS



#1948 BIPOD



FEATURES

#1948 BIPOD

- › HEIGHT 6" - 9" (15 - 22 CM)
- › WEIGHT 12.6 OZ - 360 GR
- › FOLDABLE LEGS
- › EXTENDABLE LEGS
- › RUBBERIZED FEET
- › BLACK MATTE FINISH
- › SUITABLE FOR WEAVER-PICATINNY RAIL

BIPODS FOR THE PROFESSIONALS

Built with the toughest alloy steel and equipped with a mounting system that fits the Weaver-Picatinny rail, our bipods are an ideal accessory for most rifles and will give you a stable rest while hunting or shooting.

#1949 BIPOD-T

- › HEIGHT 4.75" - 9" (1.065 - 22.86 CM)
- › WEIGHT 12.7 OZ - 360 GR
- › FOLDABLE LEGS
- › EXTENDABLE LEGS
- › RUBBERIZED FEET
- › BLACK MATTE FINISH
- › SUITABLE FOR PICATINNY RAIL WITH ADJUSTABLE QUICK RELEASE MOUNT

UNIVERSAL SMARTPHONE ADAPTER



#1303

FEATURES

- › SUPREMELY VERSATILE
- › EASY TO USE
- › LIGHTWEIGHT
- › FITS ANY GIVEN SMARTPHONE MODEL

UNIVERSAL SMARTPHONE ADAPTER

Enables you to connect your Smartphone to telescopes, microscopes, binoculars, spotting scopes and other optical instruments for taking pictures and recording videos.



FLASHLIGHTS

From tactical flashlights to headlights, the Konus range has plenty of options with unique features and unparalleled affordability.

Especially notable is their Turbo Mode that instantly provides maximum power while minimizing the battery consumption in the process.



#3932

INCLUDES ALL
THE ACCESSORIES
FOR TACTICAL
USE



FEATURES

- › RECHARGEABLE FLASHLIGHT WITH 1000 LUMENS OUTPUT
- › WEAVER/PICATINNY RING
- › REMOTE PRESSURE LIGHT
- › METAL BODY
- › CASE INCLUDED
- › 3 SELECTABLE MODES WITH MEMORY FUNCTION: HIGH - LOW - STROBE
- › 18650 LITHIUM RECHARGEABLE BATTERY INCLUDED
- › TYPE-C CHARGER INCLUDED

FLASHLIGHT WITH MOUNTING SYSTEM FOR WEAVER/ PICATINNY RAIL

This tactical flashlight with superior LED Cree technology can be either hand-held or mounted on the Weaver/Picatinny rail of any given weapon by virtue of the enclosed mounting ring. A remote controller is also part of the package for supreme versatility. This device will generate an extremely powerful light beam and will provide you with a two different intensities and flashing mode for utmost versatility. Fully made in metal, it is also rechargeable.



FEATURES

- › RECHARGEABLE FLASHLIGHT WITH 2000 LUMEN OUTPUT AND 4000 LUMEN TURBO MODE
- › 3 BRIGHTNESS LEVELS: LOW (1000 LUMENS) HIGH (2000 LUMENS) - TURBO MODE (4000 LUMENS)
- › TURN THE HANDLE OF THE FLASHLIGHT TO ACTIVATE THE LANTERN FUNCTION WITH 4 BRIGHTNESS LEVELS: 25% - 50% - 100% - RED LIGHT
- › FULL METAL BODY
- › BATTERY CHARGE LEVEL INDICATOR
- › POWER BANK FUNCTION
- › MAGNETIC BASE
- › POUCH AND USB CHARGING CABLE INCLUDED

2-IN-1 FLASHLIGHT AND LANTERN WITH TURBO MODE

This highly innovative tool is a rechargeable flashlight that can be changed into a lantern by simply turning its handle. It comes with a revolutionary Turbo Mode that instantly doubles its 2000 lumen base output, thus providing a supremely powerful 4000 lumen intensity when it is needed most while sensibly reducing the battery consumption in the process.

Other notable functions include the magnetic base, the battery charge level indicator and the power bank capability. As a lantern, it also features a red light that can be especially useful for safety and emergency purposes.



#3933 KONUSLIGHT-5K



#3934 KONUSLIGHT-RT

FEATURES

#3933 KONUSLIGHT-5K

- › RECHARGEABLE FLASHLIGHT WITH 2500 LUMEN OUTPUT AND 5000 LUMEN TURBO MODE
- › FULL METAL BODY
- › WORKS WITH ONE 20650 RECHARGEABLE BATTERY (INCLUDED)
- › 4 BRIGHTNESS LEVELS: HIGH (2500 LUMENS) - INTERMEDIATE (1000 LUMENS) - LOW (125 LUMENS) - TURBO MODE (5000 LUMENS)
- › ZOOM FUNCTION
- › WATERPROOF
- › USB CHARGING CABLE INCLUDED
- › WEIGHT: 300G-10.5OZ

WATERPROOF FLASHLIGHTS WITH TURBO MODE

In spite of their very compact size, these two rechargeable models are able to generate a truly unbelievable light output. Their key feature is the revolutionary Turbo Mode, which instantly provides maximum power when it is needed most and minimizes the battery consumption in the process. The # 3933 has a base output of 2500 lumens and a 5000 lumen Turbo Mode, while also coming with a handy zoom function. The # 3934 has a base output of 1500 lumens and a 2500 lumen Turbo Mode, while also doubling as a lantern by virtue of its rotatable head and magnetic base.

FEATURES

#3934 KONUSLIGHT-RT

- › RECHARGEABLE FLASHLIGHT WITH 1500 LUMEN OUTPUT AND 2500 LUMEN TURBO MODE
- › FULL METAL BODY
- › WORKS WITH ONE 20650 RECHARGEABLE BATTERY (INCLUDED)
- › 3 BRIGHTNESS LEVELS: HIGH (1500 LUMENS) - LOW (500 LUMENS) - TURBO MODE (2500 LUMENS)
- › STROBE AND S.O.S. FUNCTIONS
- › WATERPROOF
- › LANTERN MODE WITH ROTATABLE HEAD
- › STRONG MAGNETIC BASE AND METAL CLIP
- › USB CHARGING CABLE INCLUDED
- › WEIGHT: 220G-7.77OZ

KONUSLIGHT



LANTERN
MODE



#3930 KONUSLIGHT 2K



#3931 KONUSLIGHT RC-7

FEATURES

#3930 KONUSLIGHT 2K

- › RECHARGEABLE FLASHLIGHT WITH 1000 LUMEN OUTPUT AND 2000 LUMENS TURBO MODE
- › RECHARGEABLE LANTERN WITH 500 LUMENS OUTPUT
- › WITH STRONG MAGNETIC BASE AND METAL CLIP
- › BUILT-IN 18650 LITHIUM BATTERY
- › 4 FLASHLIGHT MODES: 100% - 20% - STROBE - TURBO
- › 2 LANTERN MODE: 100% - 20%
- › USB CABLE INCLUDED

HIGH LUMEN FLASHLIGHTS

These rechargeable models will provide you with all the power you need and then some.

The #3930 has a base output of 1000 lumens and an amazing 2000 lumen Turbo Mode, not to mention that it can also be used as a lantern.

The #3931 has a 1200 lumen output instead, while also featuring a zoom function with intensity adjustment.

FEATURES

#3931 KONUSLIGHT RC-7

- › RECHARGEABLE TACTICAL FLASHLIGHT
- › 1200 LUMEN OUTPUT WITH ZOOM FUNCTION
- › FULL METAL BODY
- › BUILT-IN 18650 LITHIUM BATTERY (RECHARGEABLE)
- › INTENSITY ADJUSTMENT OPERATED VIA DIMMER SWITCH
- › 4 MODES: HIGH - LOW - STROBE - SOS
- › USB CABLE INCLUDED



#3928 KONUSLIGHT RC-5



#3920 KONUSLIGHT 8

FEATURES

#3928 KONUSLIGHT RC-5

- › RECHARGEABLE TORCH WITH USB CABLE INCLUDED
- › ULTRA BRIGHT LED
- › 800 LUMEN OUTPUT
- › CLIP AND MAGNETIC BASE
- › RECHARGEABLE LITHIUM BATTERY 3.7V
- › USB CHARGER INCLUDED
- › ZOOM FUNCTION
- › FULL METAL BODY
- › 5 MODES: 100% LIGHT - 50% LIGHT - 25% LIGHT - FLASHING - S.O.S.

COMPACT AND PORTABLE FLASHLIGHTS

The # 3928 is a rechargeable model with an extremely compact and portable body (5'2" or 13 cm long) that is fully made of metal and packs an impressive 800 lumen output. It comes with a zoom function and 5 different modes (including S.O.S. and flashing). It also features a magnetic base for enhanced versatility.

The # 3920 is an affordable model with 120 lumen output that is especially notable for its sleek design and its zoom capability.

FEATURES

#3920 KONUSLIGHT 8

- › SET 6 PCS.
- › 120 LUMENS
- › 3 WATT
- › LENGTH CM 15.5/6.1"
- › ZOOM FUNCTION
- › ALUMINUM BODY
- › CREE XPE LED TECHNOLOGY
- › WORKS WITH 2 AA BATTERIES (INCLUDED)
- › 2 SELECTABLE INTENSITIES + FLASHING FUNCTION

KONUSFLASH



READING LIGHT



THREE SELECTABLE LIGHTS



HAND-WAVING SENSOR MODE



#3924 KONUSFLASH 7

FEATURES

#3900 KONUSFLASH 8

- › RECHARGEABLE FLASHLIGHT WITH 450 LUMEN OUTPUT AND HEADBAND
- › SENSOR MODE: THE LIGHT CAN BE TURNED ON/OFF BY SIMPLY WAVING YOUR HAND IN FRONT OF IT
- › ADJUSTABLE READING LIGHT: 100% LIGHT - 50% LIGHT - 25% LIGHT
- › 5 FLASHLIGHT MODES: TWO WHITE LIGHTS - 1 WHITE LIGHT - 1 YELLOW LIGHT - RED LIGHT - RED STROBE
- › WATERPROOF
- › THE SET INCLUDES: HEADBAND AND USB CABLE

SUPREMELY VERSATILE HEADLIGHTS WITH HAND-WAVING SENSOR

Head torches are truly indispensable tools for serious outdoorsmen that are in need of hands-free illumination. Both the # 3900 and # 3924 are rechargeable and waterproof models with high power and multiple operating modes.

They are especially notable for the presence of a sensor that enables you to instantly turn the light on and off by simply waving your hand in front of it.

FEATURES

#3924 KONUSFLASH-7

- › RECHARGEABLE FLASHLIGHT WITH 236 LUMEN OUTPUT AND HEADBAND
- › XPG LED
- › SENSOR MODE: THE LIGHT CAN BE TURNED ON/OFF BY SIMPLY WAVING YOUR HAND IN FRONT OF IT
- › BUILT-IN 800MAH LITHIUM BATTERY
- › 4 FLASHLIGHTS MODES: - HIGH - LOW - STROBE - RED STROBE
- › WATERPROOF
- › TIME FOR RECHARGING



RED LIGHT



ADJUSTABLE ANGLE



#3927 KONUSFLASH 6



ADJUSTABLE ANGLE



#3926 KONUSFLASH 5

FEATURES

#3927 KONUSFLASH-6

- › USB RECHARGEABLE FLASHLIGHT WITH HEADBAND
- › 2 W POWER
- › 100 LUMEN MAXIMUM OUTPUT
- › BUILT-IN 3.78V LITHIUM BATTERY
- › 180° ADJUSTABLE ANGLE
- › INCLUDES USB CABLE
- › 4 MODES: HIGH 100 - LOW 50% - DOUBLE RED LIGHT - FLASHING RED LIGHT

MULTI-PURPOSE HEADLIGHTS

The # 3926 is an affordable model with reduced weight for maximum comfort. The # 3927 is a super lightweight option with a fully adjustable angle and 4 operating modes.

FEATURES

#3926 KONUSFLASH 5

- › 1W POWER
- › 60 LUMEN MAXIMUM OUTPUT
- › COMFORTABLE HEADBAND
- › WORKS WITH 1 AA BATTERY (INCLUDED)
- › 45° ADJUSTABLE ANGLE
- › 4 MODES: HIGH 100% - LOW 50% - RED LIGHT - RED FLASHING LIGHT

KAEWA DRYBAGS & BACKPACKS



100%
POLYESTER
TPU



SNOW AND
SAND
PROOF



AIR
VALVE



WATERPROOF
AND MOISTURE
PROOF



#0016 KAEWA-60



100%
POLYESTER
TPU



SNOW AND
SAND
PROOF



WATERPROOF
AND MOISTURE
PROOF



WATERPROOF
ZIPPERS



#0021 KAEWA-20

LARGE DRYBAGS WITH AIR VALVE & WATERPROOF

Nothing can ruin a trip faster than a waterlogged phone or a sand-filled computer.

Whether you're enjoying a day on the water, camping with friends, or out on a hunt, valuables can easily be damaged.

The Kaewa drybags and backpacks are designed to protect all your gear from the elements.

Manufactured from 600-denier TPU, this unique fabric is rugged and durable.

FEATURES

#0016 KAEWA-60

- › AIR RELEASE VALVE
- › ADJUSTABLE SHOULDER STRAP
- › CARRY-HANDLE
- › SOFT, SUPPLE EXTERIOR, EASY TO FOLD
- › TPU LAMINATED POLYESTER
- › HIGH SHEAR & ABRASION RESISTANT
- › UV RESISTANT
- › OIL, GREASE AND CHEMICAL RESISTANT
- › MOISTURE & WATERPROOF (SUBMERSIBLE)
- › CAPACITY: 3,660 CUBIC INCHES (60 LITERS)
- › DIMENSIONS: 32"X11.5"X11.5" (80X30X30 CM)
- › WEIGHT: 17.5OZ - 496GR.

#0021 KAEWA-20

- › AIR RELEASE VALVE
- › ADJUSTABLE SHOULDER STRAP
- › CARRY-HANDLE
- › SOFT, SUPPLE EXTERIOR, EASY TO FOLD
- › TPU LAMINATED POLYESTER
- › HIGH SHEAR & ABRASION RESISTANT
- › UV RESISTANT
- › OIL, GREASE AND CHEMICAL RESISTANT
- › MOISTURE & WATERPROOF (SUBMERSIBLE)
- › CAPACITY: 3,660 CUBIC INCHES (60 LITERS)
- › DIMENSIONS: 32"X11.5"X11.5" (80X30X30 CM)
- › WEIGHT: 17.5OZ - 496GR.

KONUS BATTERIES



#3853 LR6 ALKALINE AA
BLISTER OF 4 BATTERIES



#3849 NICKEL AA RECHARGEABLE
SET 4 RECHARGEABLE BATTERIES AA TYPE 1300 MAH WITH BATTERY CHARGER (ALSO SUITABLE FOR AAA RECHARGEABLE BATTERIES) AND MICRO USB CABLE.



#3848 CR1620 LITHIUM CELL
SET 10 BLISTER OF 1 BATTERY



#3846 AA 2600 mAh RECHARGEABLE
RECHARGEABLE BLISTER OF 2 BATTERIES



#3872 LR6 ALKALINE AA G-TECH
BLISTER OF 4 BATTERIES

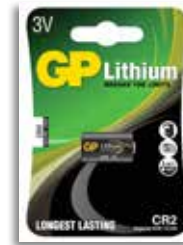

#3851 CR2 CR17355 LITHIUM 3V
BLISTER OF 1 BATTERY



#3850 CR123A CR17345 LITHIUM 3V
BLISTER OF 1 BATTERY



#3847 AAA 950 mAh RECHARGEABLE
RECHARGEABLE BLISTER OF 4 BATTERIES



#3873 LR03 ALKALINE AA G-TECH
BLISTER OF 4 BATTERIES



#3859 CR2025 LITHIUM 3V
MULTIBLISTER OF 5 BATTERIES



#3860 CR2032 LITHIUM 3V
MULTIBLISTER OF 5 BATTERIES



#3857 6LF22 ALKALINE 9V TRANSISTOR
BLISTER OF 1 BATTERY

A COMPREHENSIVE RANGE FOR EVERY NECESSITY

As an additional service to our customers, Konus is now offering a wide assortment of batteries that are at the same time long lasting and environmentally friendly. The models in our range will fit any camera, flashlight, MP3 reader, remote control, electronic equipment and so forth.

PROMOTIONAL MATERIAL



#2960
F-30 RIFLESCOPES DISPLAY
ENGLISH VERSION



#2898
EL-30 RIFLESCOPES
DISPLAY



#2969
KONUSPRO RIFLESCOPES
DISPLAY



#2966
PVC DISPLAY
FOR RIFLESCOPES

#2959
F-30 RIFLESCOPES
DISPLAY ITALIAN VERSION

#2947
ADHESIVE FOR
WINDOW
"AUTHORIZED DEALER"



KONUS STICKER
1000X230MM • 39.3"X9.05"



#2961
BINOCULARS DISPLAY

MERCHANDISING FOR THE POINT OF SALE

Knowing that the presentation of an article is pivotal to maximize its potential and its selling chances, Konus has developed some unique and eye-catching displays, banners and counters for our main lines of products.

Some of these merchandising materials are also intended as an informative tool, bearing a lot of technical data that are therefore made readily available for customers. All of these materials are offered for free as a part of special promotions, provided that some minimum purchase requirements are met: check your local Customer Service for more information.

BINOCULARS & SPOTTING SCOPES

TECHNICAL FEATURES

MAGNIFICATION:

This is the number of times that an object is being enlarged while looking at it through a binocular/spotting scope. For example, an object that is 100 yards away will appear like it is 5 yards away if it is observed with a 20x instrument .
($100 : 20 = 5$).



OBJECTIVE LENS DIAMETER:

This diameter affects the light gathering capability of the instrument. The larger the diameter, the better the luminosity and the brightness of the image.

EXIT PUPIL:

this is the size of the circle of light that is visible at the eyepiece of a binocular/spotting scope. The larger the exit pupil, the brighter the image especially in low light conditions such as at dusk or dawn. It is calculated by dividing the diameter of the objective lens by the power of the instrument: for example it will be 5mm in a 8x40 binocular ($40 : 8 = 5$).

FIELD OF VIEW:

this is the side-to-side measurement of the observed area. It is defined by the width in feet or meters of the area that is visible at 1000 yards/meters. The higher the magnification power, the narrower the field of view, unless the binocular/spotting scope features a "wide angle" construction that helps maximize the observed area.



EYE RELIEF:

this is the distance a binocular/spotting scope can be held away from the eye and still maintain the full field of view. Long eye relief optics reduce eyestrain and are much more comfortable, especially for eyeglass wearers

TYPE OF PRISMS:

optical prisms are made from either barium-crown glass (BAK-4) or borosilicate glass (BK-7). The BAK-4 prisms are of better quality and therefore provide brighter images and higher sharpness.

DIOPTRER ADJUSTMENT:

some binoculars come with a ring for fine-focus regulation that is usually provided around one eyepiece. This ring allows to compensate for vision differences between the right and left eye of the observer.

WATERPROOF:

the most professional binoculars and spotting scopes also offer the additional advantage of being waterproof, due to their special construction featuring a sealed and nitrogen purged body. These models can withstand complete immersion in water and can be exposed to the most hazardous weather conditions such as rain, fog and snow.

TYPE OF COATING

the surfaces of the lenses and prisms are coated to improve the light transmission and reduce glare, thus obtaining a brighter image with higher contrast and less eyestrain.

There are 4 types of coating:

- Coated: a single layer on at least one lens surface
- Fully coated: a single layer on all air-to-glass lens surfaces
- Multi-coated: multiple layers on at least one lens surface
- Fully multi-coated: multiple layer on all air-to-glass lens surfaces

PHASE COATING:

This advanced coating technique will force the light beams back into phase, thus improving the image definition and contrast and creating a sharper view, especially noticeable when observing fine details.

SILVER MIRROR COATING:

This incomparable technique will treat the internal prisms of the instrument to a special and highly reflective type of coating, by applying very thin layers of the finest silver material. The results in terms of resolution, brilliance and optical performance will be simply unparalleled, with a light transmission as high as 98%.



■ POWER (MAGNIFICATION):

The first number of a rifle scope (ie: 4X32) is the power or magnification. For example, the 4X indicates that the target being viewed will be four times closer versus viewing it with the naked eye. a) Typically, high powered scopes are used for motionless target or silhouette shooting; ideally, with a bench rest or some other support.

b) Lower to medium powered scopes (ie: 1.5X - 10X) offer a brighter image and a wider field of view. These scopes are ideal for areas of dense foliage. They are also the best choice when shooting at close to medium range, or at moving targets.

■ FIELD OF VIEW:

The width or distance across that can be seen through a rifle scope. This view is expressed as feet (or meters) at a distance of 100 yards (or meters). Typically, increasing your magnification will decrease your field of view.

■ CLICK VALUE:

Often referred to as windage and elevation adjustments, this feature allows the scopes aiming point to be perfectly adjusted at designated increments. For example a .25"(0.63cm) click value will change the point of impact by 1/4" at 100 yards either up or down, left or right (depending on the knob you adjust).

■ EYE RELIEF:

The distance a rifle scope can be held away from the eye while obtaining a full field of view. Long eye relief provides the shooter with a comfortable and safe distance from recoil, and allows eyeglasses wearers to get the full use of their scope.



SIDE PARALLAX WHEEL:

Parallax is a condition that occurs when the image being observed through a rifle scope is not focused precisely on the reticle plane.

Parallax is noticeable as an apparent movement between the reticle and the target when the shooter moves his head as an out of focus image.

Usually standard riflescopes are set to be parallax-free at 100 yards, but many of our models come with a special wheel that enables you to have an automatic correction of the parallax for every distance from 10 yards to infinity.

This wheel is positioned on the left side of the scope and its dimensions have been increased to facilitate the reading of the various distances and use while wearing gloves.



TACTICAL TURRETS WITH PUSH/PULL LOCKING SYSTEM:

The windage and elevation turrets of some of our models feature an innovative instant-locking system that is named "Konus Impact System". It provides a double advantage for the user: not only can they operate the turrets much faster than the ones on standard riflescopes, but they can also lock them in position thus making sure that the adjustments will not be altered even if the scope has to endure extreme abuse while in the field.



ANTI-CANTING LEVEL BUBBLE :

Being especially suited for long distance shooting, some of our riflescopes come with an anti-canting system that has been developed to deliver utmost precision while executing even the most prohibitive shots. Inside the eyepiece there is a level bubble level that is filled with fluorescent liquid in order to be perfectly visible in every lighting condition. The position of the bubble will not obstruct the field of vision and will give the shooter the chance to instantly know whether they are aiming at the target in the most effective and most balanced way. This is a gigantic innovation in the industry, a true revolution that Konus is proud to offer its customers as a worldwide exclusivity.



FAST FOCUS EYEBELL:

This feature enables the rifle scope to be instantly adjusted to suit each individual shooter's eye condition, thus ensuring the highest degree of accuracy while aiming at a target.



SEALED/WATERPROOF CONSTRUCTION:

Our riflescopes are built to withstand even the most hazardous weather conditions while always delivering an impeccable performance. Their rugged construction is 100% waterproof and they are both nitrogen purged and O-ring sealed to prevent any infiltration of rain, snow, fog, dust or moisture.



ONE PIECE TRUE 30MM TUBE DIAMETER:

The market is full of riflescopes whose outer tube diameter looks like 30mm while internally they are only 25mm. All of our 30mm models, on the contrary, feature an authentic 30mm diameter which translates into a far superior light gathering capability and therefore an unparalleled visual quality.



FLIP-UP COVERS FOR EYEPIECE AND OBJECTIVE:

All of our riflescopes are equipped with strong black plastic covers to protect their eyepiece and objective. Some of these covers are of the Flip-Up type and thus they can be instantly opened and closed with nothing more than the user's fingertips.



SUNSHADE:

Many of our riflescopes include a threaded sunshade that can be screwed onto the objective to help reduce glare and enhance contrast while shooting in bright conditions, as well as reduce the effect of rising heat known as "mirage".



ENGRAVED RETICLE:

All of our riflescopes (except the #7235, #7350 and #7351) have a reticle that is etched onto precision glass, instead of using a metal wire. These reticles are therefore guaranteed to withstand even the heaviest recoil on the most powerful guns, while also being especially thin.

1/10

1/10 MIL TURRETS:

The 1/10 Mil turrets are an ideal choice when coupled with a Mil-Dot reticle, since they will enable you to achieve the maximum precision in the shortest possible time. When you take a shot, in fact, you can easily estimate where, in Mil relation, the bullet impacted relative to the point of aim with the reticle and you can then make the necessary adjustments easily and instantly. For example, let's say that your bullet landed 2 Mils left and 1 Mil low: all you have to do is to adjust your scope 20 clicks right (20 clicks = 2 Mils) and 10 clicks up (10 clicks = 1 Mil) and then you will be ready for your second shot. Had your scope been equipped with MOA adjustments instead, you would have had to do a conversion between Mils and MOA which is not always easy or practical. This explains why the 1/10 Mil turrets have become an invaluable asset in the tactical field, where quick reactions are of the essence and there is no room for errors.

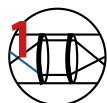

RETICLE ON THE FIRST FOCAL PLANE (EUROPEAN CONSTRUCTION SYSTEM):

Our F30 riflescopes are built according to the European system and their reticle is therefore positioned on the first focal plane. The main advantage of this configuration is that the reticle will change in size when zooming in and out, thus enabling you to use a tactical reticle (like the Mil-Dot) for rangefinding purposes at any given magnification.



RETICLE ON THE SECOND FOCAL PLANE (AMERICAN CONSTRUCTION SYSTEM):

While the European construction system places the reticle on the first focal plane, all of our riflescopes (except the F30 models) are built according to the American system and thus their reticle is placed on the second focal plane. This is important while shooting at very small targets or at very distant ones.



FULLY MULTI-COATED OPTICS:

Every lens and prism throughout the body of the M30 and F30 riflescopes feature 10 layers of coating on all air-to-glass surfaces in order to ensure the maximum light transmission (over 95%).

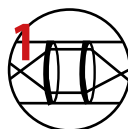
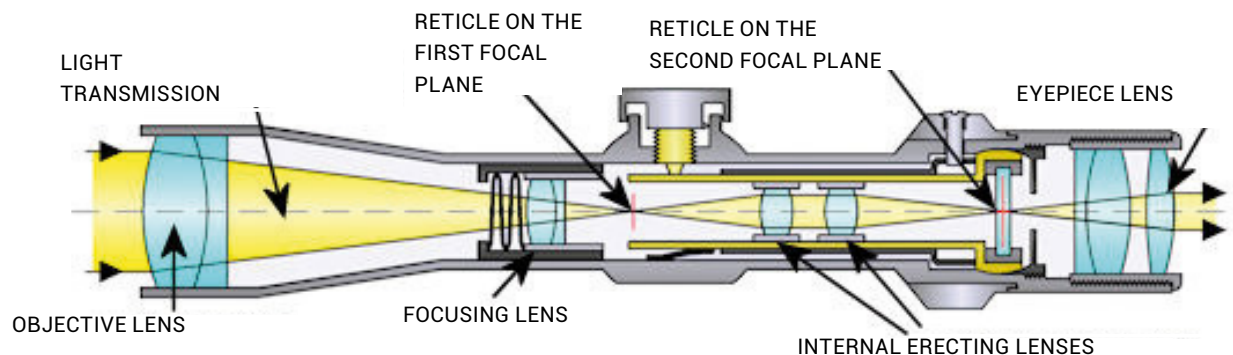

RETICLE ON THE FIRST FOCAL PLANE:

The above picture shows the difference, in terms of construction, between a first focal plane riflescope and a second focal plane riflescope. Such a difference is easily identified by using the zoom ring. When you zoom to a high magnification, the reticle of a first focal plane model gets bigger. When you zoom out (lower magnification), the reticle gets smaller. With a second plane scope, on the contrary, the reticle size never changes while zooming in or out. The reticle changing size plays a significant role in using a tactical reticle, such as the Mil-Dot: in a first focal plane scope, the target-to-reticle ratio is maintained throughout all the magnifications without any shift of the point of impact. You can therefore utilize your reticle for rangefinding purposes at any magnification.

With a second plane scope, on the contrary, the calculation of the distance will be possible at a set magnification only (usually 10x or 12x). The most demanding long range shooters, such as the military snipers, will therefore prefer a first focal plane riflescope in order to take advantage of its improved accuracy.

RETICLE ASSORTMENT



30/30 RETICLE:

Four thick posts at opposite sides from one another, connected by a fine crosshair that intersects at the center. A key feature of the 30/30 reticle is its ability to measure distance.

The thick posts (end to end) equal 30"(75cm) across at 4X 100 yards (91m). (FYI: 30" is the approximate distance of an average sized adult deer from his chest to his rump).



If the same 30" target stretches the distance of the reticle, then it would be 200 yards (182m) away, etc.

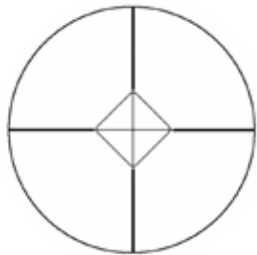

AIM-PRO RETICLE:

Exclusive Konus reticle used in conjunction with our #7249 riflescope to provide an exact aiming point through the center diamond. This dual aim point also helps establish distance, as a turkey's head will fill the diamond at 40 yards (36.5m), while an adult deer's target area fills the view at 75 yards (68.5m).

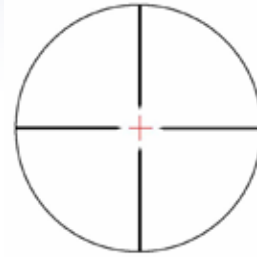

ILLUMINATED RETICLES:

Crosshairs with the ability to light or glow a red color. This is an excellent choice for low light conditions or for shooting against very dark targets. The intensity of the illumination can be adjusted up or down for any lighting conditions.

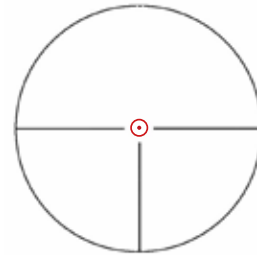

CIRCLE DOT RETICLE:

This reticle is an ideal choice while shooting at close or medium distance. The illuminated circle will enable an easier acquisition of fast moving targets, while the illuminated dot will provide a significant advantage when you need to take a shot with utmost accuracy.

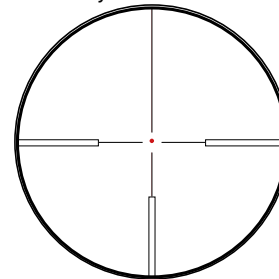

GERMAN-4 RETICLE

This reticle is nearly identical to a 30/30 reticle but it does not have an emboldened top post. The crosshair is the same width from the center all the way to the top of the sight picture. The German-4 reticle has always been among the most popular ones for hunting purposes.

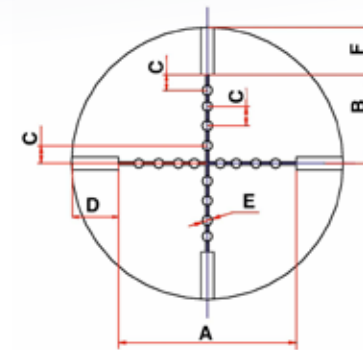

	M.O.A*	MIL
A	34.38	10
B	17.19	5
C	3.44	1
D	63.03	18.3
E	0.69	0.2
F	63.03	18.3

* Minute of angle

MIL-DOT RETICLE:

This special tactical reticle was originally developed by the U.S. Marine Corps so that their snipers could accurately measure the distance from the target and could also compensate for strong crosswinds. In our riflescopes, these reticles are also etched onto precision glass, which means that they will never break, spin or dislodge even if they are used on powerful guns with heavy recoil.

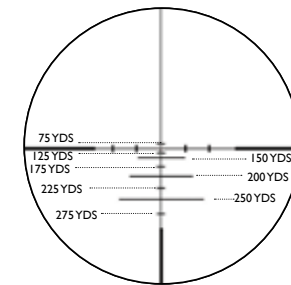

275 BALLISTIC RETICLE

This reticle is featuring several aiming points that are calibrated from 75 to 275 yards and coincide with the most popular black powder loads. Lateral hash marks have also been added to compensate for wind. This reticle consequentially provides an undeniable advantage in terms of improved accuracy and better performance.

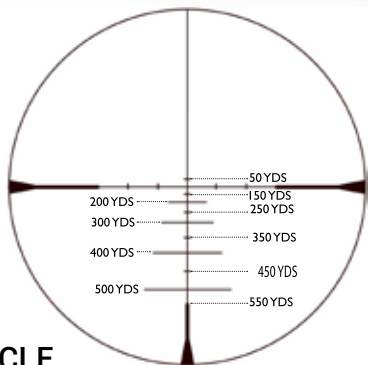

550 BALLISTIC RETICLE

This reticle will give you the ability to shoot with utmost precision out to 550 yards, thus effectively taking your game to the next level and dramatically improving your accuracy. It works with a system of aiming points that correspond to different distances and are based on the most popular centerfire and black powder loads. Furthermore, you are also provided with lateral hash marks that allow for compensation in case of strong crosswinds. This reticle is therefore ideal for performance-driven long distance shooters that want to be supremely confident while attempting even the most prohibitive shot.

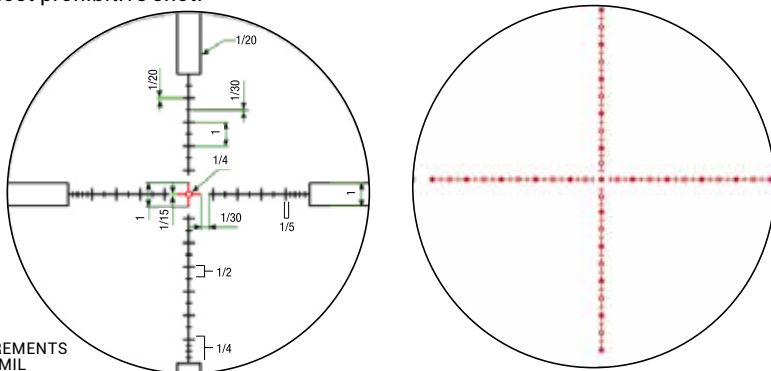

ALL MEASUREMENTS ARE IN MIL

MODIFIED HALF MIL-DOT RETICLE:

Some reticles, originally developed for tactical purposes, enable you to accurately measure your distance from the target if you know the dimensions of what you are aiming at. When a reticle is placed on the second focal plane, the calculation of the distance is possible at a set magnification only (usually 10x or 12x). When a reticle is placed on the first focal plane, on the contrary, the target-to-reticle ratio never changes and you can therefore utilize your riflescope at any magnification while determining your distance from the target. The most popular choice among tactical reticles is the Mil-Dot. Some of our riflescopes, like the Konuspro F-30 series, feature a modified version of the Mil-Dot for enhanced accuracy and precision: the space between hash marks is not 1 Mil (as in the standard Mil-Dot configuration), but 1/2 Mil. Furthermore, the illuminated "quick-peep" center crosshair removes any chance of obstructing your vision even if you are aiming at very small targets or shooting long range.

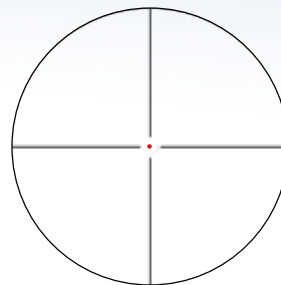

FINE CROSSHAIR RETICLE

This reticle has a supremely thin crosshair and a center dot of reduced size. It is therefore very useful while shooting at very long range, since it will not end up covering the target and obstructing its acquisition.

PRS BALLISTIC RETICLE

This is undoubtedly the most accurate reticle for the Precision Rifle Series (PRS) and for the other long range shooting competitions. It features a large number of aiming points in a "Christmas tree" pattern that enable the shooter to calculate how the bullet drop and the crosswind are affecting the trajectory of a projectile at any given distance. Being an evolution of the Mil-Dot Reticle, this reticle is typically associated with First Focal Plane riflescopes whose turrets have 1/10 MIL adjustments.

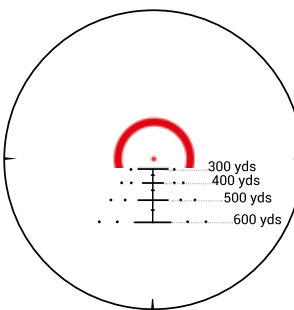
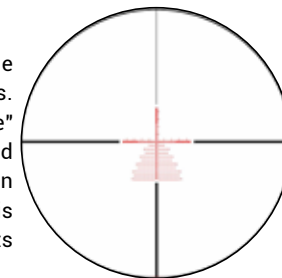

BALLISTIC-CIRCLE RETICLE

The exclusive Ballistic-Circle reticle of Konus has been developed with the purpose of facilitating rapid and accurate shooting up to a distance of 600 yards. It can be especially effective with any of the most popular loads, being based on Minute of Angle (MOA) subtensions. Once your rifle has been zeroed, you will be able to use the lower hashmarks to calculate the bullet drop when aiming at targets at various distances. This reticle can also be used when dialing windage adjustments, with each lateral line or dot representing a 5 MPH increment in crosswind speed at a set distance (up to 15 MPH).

BALLISTIC RETICLE

Developed for hunting purposes, this practical and easy-to-use reticle enables shooters to quickly and accurately calculate the bullet drop at various distances (up to 400 yards).

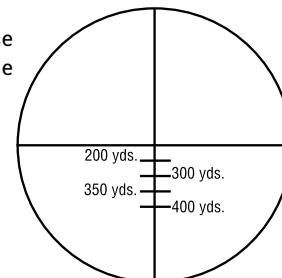

По вопросам продаж и поддержки обращайтесь:

Алматы (727)345-47-04
Ангарск (3955)60-70-56
Архангельск (8182)63-90-72
Астрахань (8512)99-46-04
Барнаул (3852)73-04-60
Белгород (4722)40-23-64
Благовещенск (4162)22-76-07
Брянск (4832)59-03-52
Владивосток (423)249-28-31
Владикавказ (8672)28-90-48
Владимир (4922)49-43-18
Волгоград (844)278-03-48
Вологда (8172)26-41-59
Воронеж (473)204-51-73
Екатеринбург (343)384-55-89

Иваново (4932)77-34-06
Ижевск (3412)26-03-58
Иркутск (395)279-98-46
Казань (843)206-01-48
Калининград (4012)72-03-81
Калуга (4842)92-23-67
Кемерово (3842)65-04-62
Киров (8332)68-02-04
Коломна (4966)23-41-49
Кострома (4942)77-07-48
Краснодар (861)203-40-90
Красноярск (391)204-63-61
Курск (4712)77-13-04
Курган (3522)50-90-47
Липецк (4742)52-20-81

Магнитогорск (3519)55-03-13
Москва (495)268-04-70
Мурманск (8152)59-64-93
Набережные Челны (8552)20-53-41
Нижний Новгород (831)429-08-12
Новокузнецк (3843)20-46-81
Ноябрьск (3496)41-32-12
Новосибирск (383)227-86-73
Омск (3812)21-46-40
Орел (4862)44-53-42
Оренбург (3532)37-68-04
Пенза (8412)22-31-16
Петрозаводск (8142)55-98-37
Псков (8112)59-10-37
Пермь (342)205-81-47

Ростов-на-Дону (863)308-18-15
Рязань (4912)46-61-64
Самара (846)206-03-16
Санкт-Петербург (812)309-46-40
Саратов (845)249-38-78
Севастополь (8692)22-31-93
Саранск (8342)22-96-24
Симферополь (3652)67-13-56
Смоленск (4812)29-41-54
Сочи (862)225-72-31
Ставрополь (8652)20-65-13
Сургут (3462)77-98-35
Сыктывкар (8212)25-95-17
Тамбов (4752)50-40-97
Тверь (4822)63-31-35

Тольятти (8482)63-91-07
Томск (3822)98-41-53
Тула (4872)33-79-87
Тюмень (3452)66-21-18
Ульяновск (8422)24-23-59
Улан-Удэ (3012)59-97-51
Уфа (347)229-48-12
Хабаровск (4212)92-98-04
Чебоксары (8352)28-53-07
Челябинск (351)202-03-61
Череповец (8202)49-02-64
Чита (3022)38-34-83
Якутск (4112)23-90-97
Ярославль (4852)69-52-93

Россия +7(495)268-04-70

Казахстан +(727)345-47-04

Беларусь +(375)257-127-884

Узбекистан +998(71)205-18-59

Киргизия +996(312)96-26-47

эл.почта: kun@nt-rt.ru || сайт: <http://konuscopes.nt-rt.ru/>